

OUTDOOR

An advanced level of design and engineering that is equipped to meet the challenges of varying temperature, sunlight, water, ingress and corrosion. Through a rigorous manufacturing process and quality control, Reiz ensures that each light in the outdoor range meets high quality standards. The range comprises lights from IP-55 to IP-68 (underwater).

Each luminaire is 100% safe, corrosion resistant and complies with strict European Norms.



INGROUND BURIAL

With strong construction and sturdy design to ensure weight bearing, these outdoor luminaires can withstand changing temperature and weather conditions. The long lasting silicon gasket makes it a waterproof fixture that can be customised using LED colors, optics and covers.

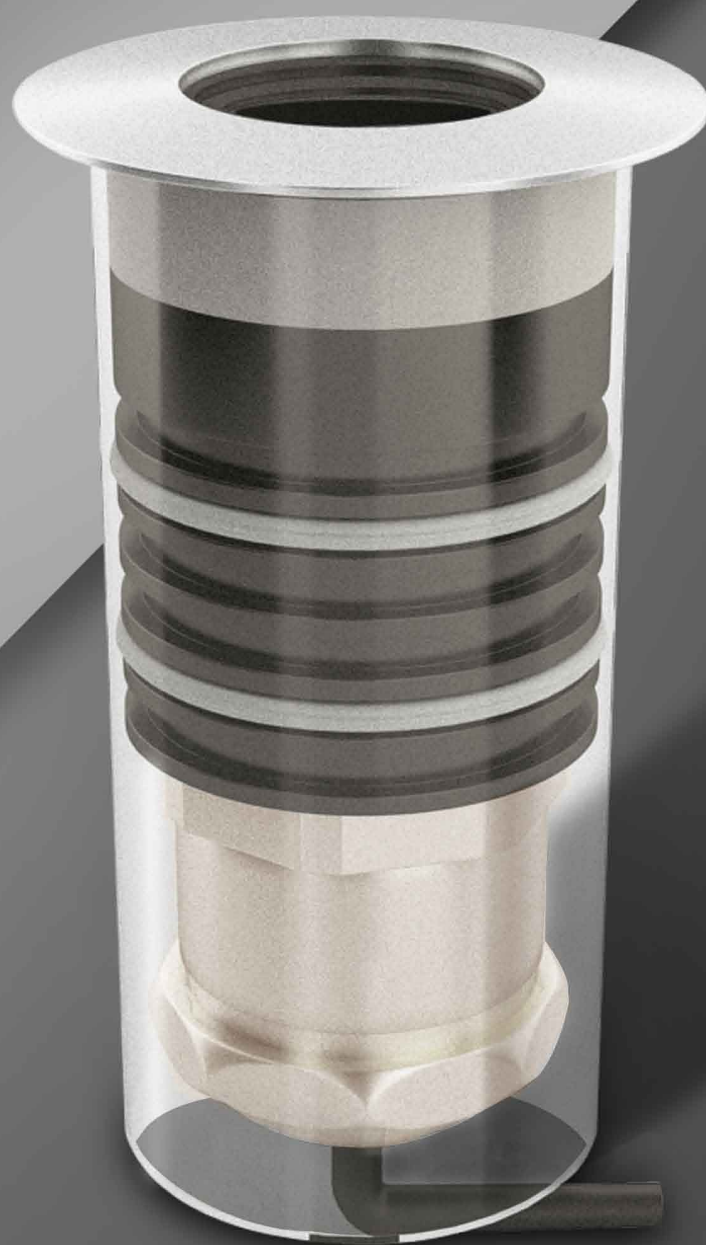

Volcano Micro

Volcano Micro

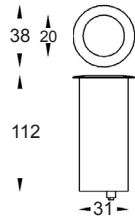

0670000201 0 0 00

2W 179lm 6000K
Cut Off Angle : 22°

Led Color	Optics	Finish
C 6000K	12°	W White
N 4000K	24°	B Black
W 3000K	36°	S Silver

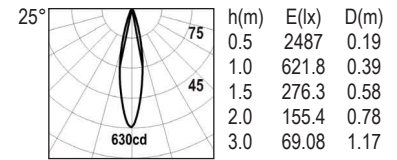

0670000301 0 0 00

3W 286lm 6000K
Cut Off Angle : 22°

Led Color	Optics	Finish
C 6000K	12°	W White
N 4000K	24°	B Black
W 3000K	36°	S Silver

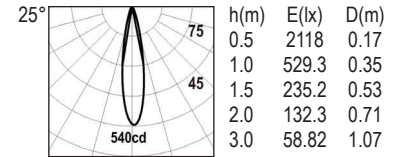

- Inground up light as a marker/accentuating light for LED lamps for mounting into concrete surface
- Construction - inner casing in anodized aluminium for better heatsink & top flange in electropolished in SS-304/SS-316
- Silicone gasket for moisture protection
- Toughened step extra clear safety glass 4mm

- incorporated to avoid dirt contamination
- Extruded aluminium for better heatsink of LED
- For walk over static load maximum 500 kg
- Rubber H07 RNF cable length for IP-67 = 1mtr. for IP-68 = 3mtr with gland
- Additional cable length to be ordered separately

- Wire for mains supply cable 2c×1.5mm²
- IP 67 Connector for water proof joint.
- Reiz Electronic LED driver 24V DC remote 24V, THD<10% PF>0.95, LED CRI : 85
- Optional Integrated LED Driver

Volcano Milli

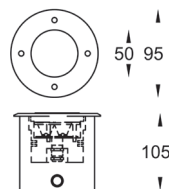

0690000801 0 0 00

8W 780lm 6000K
Cut Off Angle : 18°

Led Color	Optics	Finish
C 6000K	12°	4 SS304
N 4000K	24°	6 SS306
W 3000K	36°	

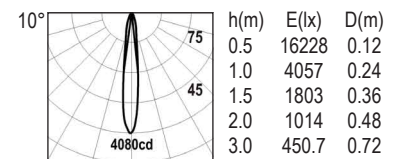

0690000204 0 0 00

12W, 1230lm 6000K
Cut Off Angle : 25°

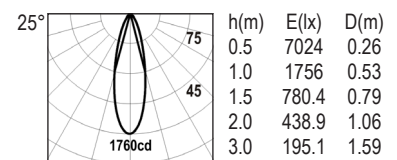

0690000103 DF0 0 00

4W, 270lm 6000K



- Inground up light for LED for mounting into concrete surface - flush recessed mounting in compacted surfaces, pathways and squares
- Available as a walk over static load maximum 1 ton.
- Construction - inner casing in anodized aluminium for better heatsink & top flange in electropolished in SS-304/SS-316
- Also in available in diffused model
- Generous flange widths for easy covering of

- holes
- Double silicone gasket for moisture protection
- Polyester powder coated with high U.V. & corrosion resistance
- Toughened step extra clear safety glass 8mm incorporated to avoid dirt contamination
- Extruded aluminium for better heatsink of LED
- Rubber H07RNF cable length for IP-67 = 1mtr, for IP-68 = 3mtr with gland

- Additional cable length to be ordered separately
- Wire for mains supply cable 3c×1.5mm²
- IP-68 fast connector integrated for cable O.D. 6-10mm
- Reiz Electronic LED driver 24V DC remote, THD<10% PF>0.95, LED CRI : 85
- Optional Integrated LED Driver

Volcano Milli Directional



06905400801 0 00

8W 775lm 6000K
Cut Off Angle : 18°

Led Color	Optics	Finish
C 6000K	12°	W White
N 4000K	24°	B Black
W 3000K	36°	S Silver

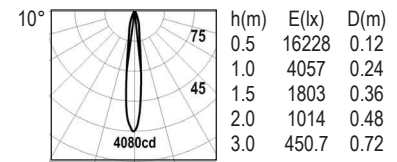

06905400204 0 00

12W 1005lm 6000K
Cut Off Angle : 25°

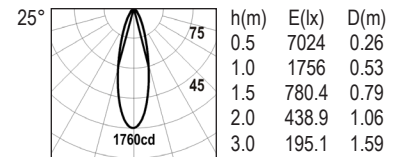

▲ Dia 95
Circular Flange



▲ 95x95
Square Flange



- Inground directional LED up light for mounting into concrete surface, used for wall washing.
- flush recessed mounting for walk over-1 ton or underwater application
- Lamp position fixed at 15°
- Construction - inner casing in anodized aluminium for better heatsink & top flange in electropolished in SS-304/SS-316

- Construction - outer housing in aluminium with open bottom for water drainage
- Double silicone gasket for moisture protection
- Polyester powder coated with high U.V. & corrosion resistance
- Toughened step extra clear safety glass 8mm incorporated to avoid dirt contamination
- Rubber H07RNF cable length for IP-67 = 1mtr, for IP-68 = 3mtr with gland

- Additional cable length to be ordered separately
- Wire for mains supply cable 3c×1.5mm²
- IP-68 fast connector integrated for cable O.D. 6-10mm
- Reiz Electronic LED driver 24V DC remote, THD<10% PF>0.95
- LED CRI : 85

Volcano Mini

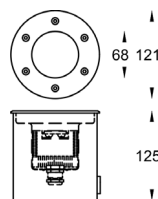

08500000207 0 00

16W 1503lm 6000K
Cut Off Angle : 20°

Led Color	Optics	Finish
C 6000K	12°	W White
N 4000K	24°	B Black
W 3000K	36°	S Silver

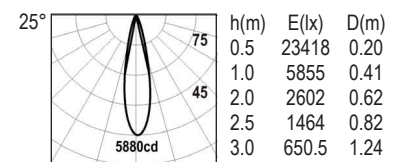

06905400204 0 00

12W 1005lm 6000K
Cut Off Angle : 25°



▲ Dia 121
Circular Flange



▲ 121X121
Square Flange



- Inground up light as a directional spot light for LED for mounting into concrete surface
- Available as a walk over, drive over or underwater application
- Construction - outer housing in aluminium with pre drilled holes for water drainage, inner casing in electropolished SS-304 to give long life & top flange in electropolished in SS-304/SS-316

- Double silicone gasket for moisture protection
- Polyester powder coated with high U.V. & corrosion resistance
- Toughened step extra clear safety glass 10mm incorporated
- For walk over static load maximum 2 tons and for drive over maximum 4 tons @ 30km/hrs
- Extruded aluminium for better heatsink of LED
- Moisture control device to reduce misting on glass

- Rubber H07RNF cable length for IP-67 = 1mtr, for IP-68 = 2mtr with gland
- Additional cable length to be ordered separately
- Wire for mains supply cable 3c×1.5mm²
- IP-68 fast connector integrated for cable O.D. 6-10mm
- Reiz Electronic LED driver constant current integrated, THD<10% PF>0.95
- LED CRI : 85

Volcano Maxx

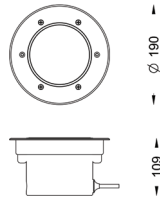

18500000112 0 00
 15W 1375lm 6000K
 Cut Off Angle : 12°

Led Color	Optics	Finish
C 6000K	12°	W White
N 4000K	24°	B Black
W 3000K	36°	S Silver

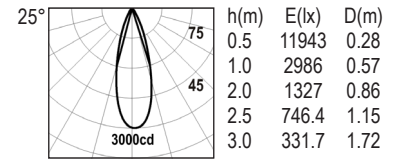

18500000212 0 00
 26W 2250lm 6000K
 Cut Off Angle : 12°

Led Color	Optics	Finish
C 6000K	12°	W White
N 4000K	24°	B Black
W 3000K	36°	S Silver

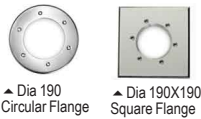
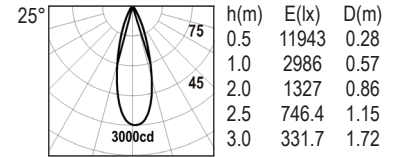

- Inground directional up light for LED for mounting into concrete surface
- Available as walkover, drive over and under water application
- Construction - outer housing in aluminium with pre drilled holes for water drainage, inner casing in electropolished SS-304 to give long life & top flange in electropolished in SS-304/SS-316
- Double silicone gasket for moisture protection

- Polyester powder coated with high U.V. & corrosion resistance
- Toughened step extra clear safety glass 12mm incorporated to avoid dirt contamination
- For walk over static load maximum 2 tons and for drive over maximum 5 tons @ 30km/hrs
- Extruded aluminium for better heatsink of LED
- Moisture control device to reduce misting on glass

- Rubber H07RNF cable length for IP-67 = 1mtr, for IP-68 = 3mtr with gland
- Additional cable length to be ordered separately
- Wire for mains supply cable 3c×1.5mm²
- IP-68 fast connector integrated for cable O.D. 6-10mm
- Reiz Electronic LED driver 24V constant voltage remote, THD<10% PF>0.95
- LED CRI : 85

Volcano Maxx D

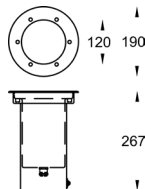

08700000212 1 00
 26W 2305lm 6000K
 Cut Off Angle : 12°

Led Color	Optics	Finish
C 6000K	12°	W White
N 4000K	24°	B Black
W 3000K	36°	S Silver

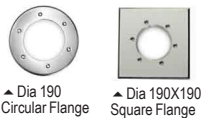
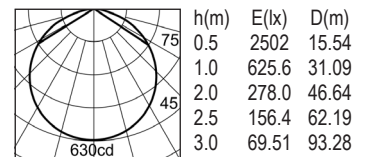

- Inground fixed up light for LED mounting into concrete surface.
- Driver is integrated within Linear where depth is available
- Available as walk over, drive over or under water application.
- Construction outer housing in aluminium with pre drilled holes for water drainage, inner casing in 304 electro polished SS-304 to give long life & top flange in electro polished in SS-304/SS-316.

- Double silicone gasket for moisture protection.
- Polyester powder coated with high U.V. corrosion & resistance.
- Toughened step extra clear safety glass 12mm incorporated to avoid dirt contamination.
- For walk over static load maximum 2 tons and for drive over maximum 5 tons @ 30km/hrs
- Extruded aluminium for better heat sink of LED.
- Moisture control device to reduce misting on glass

- Rubber H07RNF cable length for IP-67= 1mtr, for IP-68= 3mtr with gland.
- Wire for mains supply cable upto 3c×1.5 mm².
- Reiz Electronic LED driver constant current integrated, THD<10% PF>0.95
- LED CRI : 85

Volcano Mega

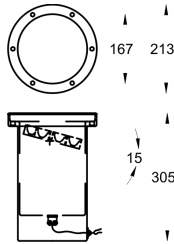

08800000212 1 00

26W 2255lm 6000K
Cut Off Angle : 15° Optics :

Led Color	Optics	Finish
C 6000K	12°	W White
N 4000K	24°	B Black
W 3000K	36°	S Silver

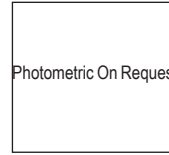

08800000312 1 00

40W 3450K
Optics :

Led Color	Finish
C 6000K	W White
N 4000K	B Black
W 3000K	S Silver



▲ Dia 213
Circular Flush



- Inground directional up light for LED for mounting into concrete surface
- Driver is integrated within Linear where depth is available
- Available as a walk over, drive over or under water application
- Construction - outer housing in aluminium with pre drilled holes for water drainage, inner casing in electropolished SS-304 to give long life & top flange in electropolished in SS-304/SS-316

- Double silicone gasket for moisture protection
- Lamp position adjustable ±15°
- Polyester coated with high U.V. & corrosion resistance
- Toughened step extra clear safety glass 10mm incorporated to avoid dirt contamination
- For walk over static load maximum 2 tons and for drive over maximum 5 tons @ 30km/hrs
- Extruded aluminium for better heatsink of LED
- Self resetting thermal protection device to protect unit from over heating

- Moisture control device to reduce misting on glass
- Rubber H07RNF cable length for IP-67 = 1mtr, for IP-68 = 3mtr with gland
- Additional cable length to be ordered separately
- Wire for mains supply cable 3c×1.5mm²
- IP-68 fast connector integrated for cable O.D. 6-10mm
- Reiz Electronic LED driver constant current integrated, THD<10% PF>0.95
- LED CRI : 85

Pathfinder Milli

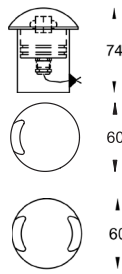

06814200201 000 700
 2W 185K 6000K
 Optics :
 Led Color Finish
 C 6000K W White
 N 4000K B Black
 W 3000K S Silver

06814300202 000 700
 5W 410lm 6000K
 Cut Off Angle : 55° Optics : 180°
 Led Color Finish
 C 6000K W White
 N 4000K B Black
 W 3000K S Silver

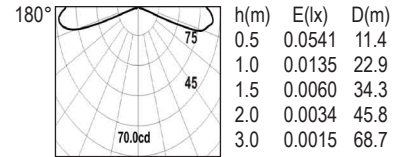

- Inground side emitting light for LED lamps mounting into concrete surface
- Available as a walk over & drive over burial light for Single & double sided illumination of roads
- Construction - outer housing in polycarbonate with high U.V. & corrosion resistance, inner casing in electropolished SS-304 to give long life & top cover in screwless SS-304/SS-316

- Clear Polycarbonate tube incorporated to avoid dirt
- Double silicone gasket for moisture protection
- Rubber H07RNF cable 1mtr with cable gland
- For walk over static load maximum 1 ton and for drive over maximum 2 tons @ 30km/hrs
- Wire for mains supply cable 2c×1.5mm²

- IP-67 fast connector integrated for cable O.D. 6-10mm
- Reiz Electronic LED driver 24V DC remote, THD<10% PF>0.95
- LED CRI : 85

Pathfinder Mini

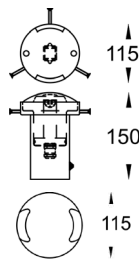

08514300202 000 D00
 5W 405lm 6000K
 Cut Off Angle : 55° Optics : 75°
 Led Color Finish
 C 6000K W White
 N 4000K B Black
 W 3000K S Silver

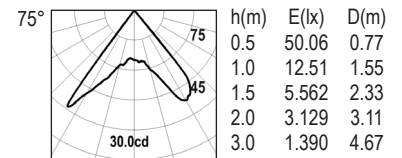

- Inground side emitting light for LED lamps mounting into concrete surface
- Available as a walk over & drive over burial light for single/double sided illumination of roads
- Construction - outer housing in electropolish SS-304, inner casing in electropolished SS-304 to give long life & top cover in aluminium with polyester powder coating

- Extra clear dome safety glass incorporated to avoid dirt contamination
- Double silicone gasket for moisture protection
- Rubber H07RNF cable 1mtr with cable gland
- For walk over static load maximum 1 ton and for drive over maximum 2 tons @ 30km/hrs
- Wire for mains supply cable 2c×1.5mm²

- IP-67 fast connector integrated for cable O.D. 6-10mm
- Reiz Electronic LED driver 24V DC remote, THD<10% PF>0.95
- LED CRI : 85

Pathfinder Maxx

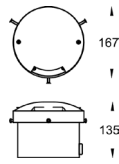

18514200202 001 00
 5W 440lm 6000K Single Throw
 Cut off Angle : 50° Optics :

Led Color	Finish
C 6000K	W White
N 4000K	B Black
W 3000K	S Silver

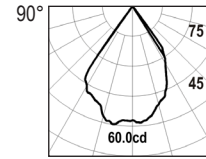

h(m)	E(lx)	D(m)
0.5	228.3	0.67
1.0	57.07	1.34
1.5	25.36	2.01
2.0	14.26	2.69
3.0	6.341	4.03

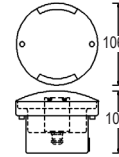

18514300204 001 00
 10W 810lm 6000K Double Throw
 Optics :

Led Color	Finish
C 6000K	W White
N 4000K	B Black
W 3000K	S Silver

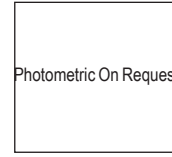

- Inground side emitting light for LED lamps mounting into concrete surface
- Available as a walk over & drive over burial light for single or double sided illumination of roads
- Construction - outer housing & top cover in aluminium polyester powder coated with high U.V. & corrosion resistance, inner casing in electropolished SS-304 to give long life

- Extra clear dome safety glass incorporated to avoid dirt contamination
- Double silicone gasket for moisture protection
- Rubber H07RNF cable 1mtr with cable gland
- For walk over static load maximum 1 ton and for drive over maximum 2 tons @ 30km/hrs

- Wire for mains supply cable 2c×1.5mm²
- IP-67 fast connector integrated for cable O.D. 6-10mm
- Reiz Electronic LED driver 24V DC integrated, THD<10% PF>0.95
- LED CRI : 85

Streak



2720000R224 ■ 00147DF

7W 625lm 6000K

Optics :

Led Color	Finish
C 6000K	W White
N 4000K	B Black
W 3000K	S Silver

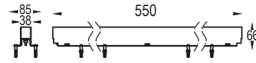
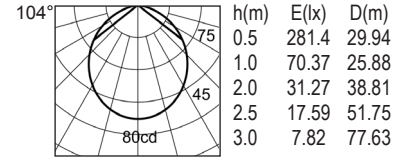

2760000R248 ■ 00147DF

10W 950lm 6000K

Optics :

Led Color	Finish
C 6000K	W White
N 4000K	B Black
W 3000K	S Silver

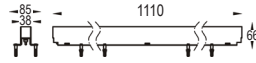
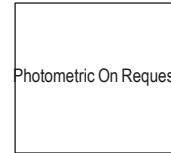

270000R1564 ■ 0014700

15W 1370lm 6500K

Optics :

Led Color	Finish
C 6000K	W White
N 4000K	B Black
W 3000K	S Silver

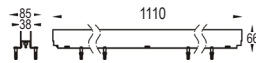
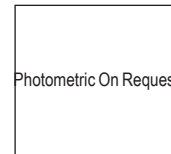

2700000R272 ■ 00147DF

20W 1870lm 2700K

Optics :

Led Color	Finish
C 6000K	W White
N 4000K	B Black
W 3000K	S Silver

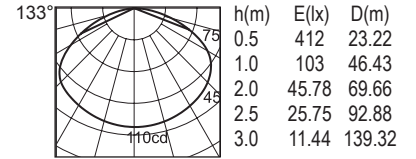

- Linear burial LED luminaire for use as a up light, marker and wash light for pathways & building illumination
- Construction - outer housing in SS-304, inner casing in extruded anodized aluminium for better heatsink
- Silicone gasket for moisture protection

- For walk over static load maximum 1 ton
- Extruded aluminium for better heatsink of LED
- High efficiency polycarbonate diffuser used for marker light
- Additional cable length to be ordered separately
- Wire for mains supply cable 3c×1.5mm²

- IP-67 fast connector integrated for cable O.D. 6-10mm
- Reiz Electronic LED driver constant current integrated, THD<10% PF>0.95
- LED CRI : 85

FLOOR WASHER

An elegant example of smart technique for providing glare free floor washing to be used in pathways & walkways. A subtle and minimalistic design that can also be personalised using LED color and finish.



Cascade Mini

Cascade Micro

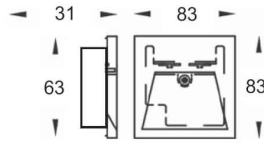

15600000201 001 500
 3W 275lm 6000K
 Cut Off Angle : 20° Optics : 104°
 Led Color Finish
 C 6000K W White
 N 4000K B Black
 W 3000K S Silver

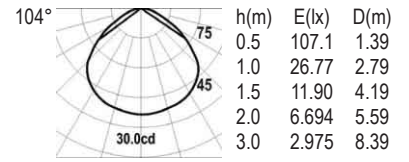

15600000202 001 500
 5W 445lm 6000K
 Cut Off Angle : 20° Optics : 104°
 Led Color Finish
 C 6000K W White
 N 4000K B Black
 W 3000K S Silver

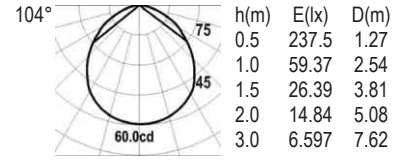

- For glare free floor lighting application, for indicating direction by washing pathways, for interior & exterior lighting application
- Construction in single piece die-cast aluminium
- Recessed pre installation housing for concrete installation

- Silicone gasket for moisture protection
- Rubber H07RNF cable 0.5 meter with cable gland
- All hardware in SS-304
- Toughened extra clear safe glass 3.2mm
- Polyester powder coated with high U.V. & corrosion resistance

- Extruded aluminium for better heatsink of LED
- Wire for mains supply cable 3x1.5mm²
- Reiz Electronic LED driver constant current integrated, THD<10% PF>0.95
- LED CRI : 85

Cascade Mini

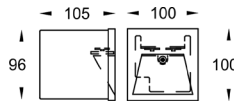

1560000201 001 500

3W 275lm 6000K
Cut Off Angle : 20° Optics : 104°
Led Color Finish
C 6000K W White
N 4000K B Black
W 3000K S Silver

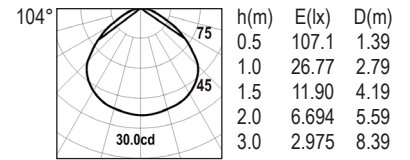

1560000202 001 500

5W 445lm 6000K
Cut Off Angle : 20° Optics : 104°
Led Color Finish
C 6000K W White
N 4000K B Black
W 3000K S Silver

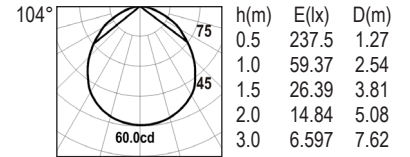

- For glare free floor lighting application, for indicating direction by washing pathways, for interior & exterior lighting application
- Construction in single piece die-cast aluminium
- Recessed pre installation housing for concrete installation

- Silicone gasket for moisture protection
- Rubber H07RNF cable 0.5 meter with cable gland
- All hardware in SS-304
- Toughened extra clear safe glass 3.2mm
- Polyester powder coated with high U.V. & corrosion resistance

- Extruded aluminium for better heatsink of LED
- Wire for mains supply cable 3c×1.5mm²
- Reiz Electronic LED driver constant current integrated, THD<10% PF>0.95
- LED CRI : 85

Cascade Maxx

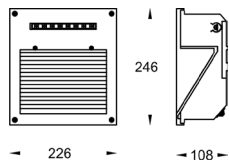

11409200112 001 500

15W 1375lm 6000K
Cut Off Angle : 25° Optics : 180°
Led Color Finish
C 6000K W White
N 4000K B Black
W 3000K S Silver

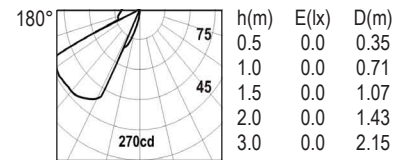

- For glare free floor lighting application, for indicating direction by washing pathways, for interior & exterior lighting application
- Construction in single piece die-cast aluminium
- Silicone gasket for moisture protection
- Rubber H07RNF cable 0.5 mtr with cable gland

- All hardware in SS-304
- Toughened extra clear safety glass 3.2mm incorporated
- Polyester powder coated with high U.V. & corrosion resistance
- Extruded aluminium for better heatsink of LED

- Moisture control device to reduce misting on glass
- Wire for mains supply cable 3c×1.5mm²
- Reiz Electronic LED driver constant current integrated, THD<10% PF>0.95
- LED CRI : 85

Torrent H

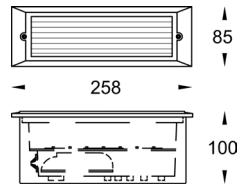

07403100108 001 500
 8W 705lm 6000K
 Cut Off Angle : 40° Optics : 51°
Led Color **Finish**
 C 6000K W White
 N 4000K B Black
 W 3000K S Silver

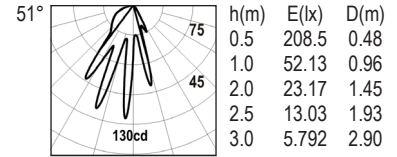

▲ Stainless Steel Louvers



- Horizontal front louvers of SS-304/aluminium Machined at an angle to provide glare free pathway Light
- Construction in single piece die-cast aluminium
- Recessed pre installation housing for concrete installation
- Silicone gasket for moisture protection
- Rubber H07RNF cable 0.5 meter with cable gland
- All hardware in SS-304
- Toughened extra clear safety glass 3.2mm incorporated
- Polyester powder coated with high U.V. & corrosion resistance
- Extruded aluminium for better heatsink of LED
- Moisture control device to reduce misting on glass
- Wire for mains supply cable 3c×1.5mm²
- Reiz Electronic LED driver constant current integrated, THD<10% PF>0.95
- LED CRI : 85

Torrent V

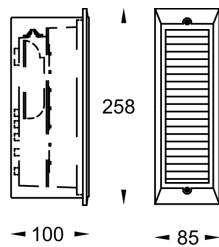

07403300108 001 500
 8W 715lm 6000K
 Cut Off Angle : 40° Optics : 58°
Led Color **Finish**
 C 6000K W White
 N 4000K B Black
 W 3000K S Silver

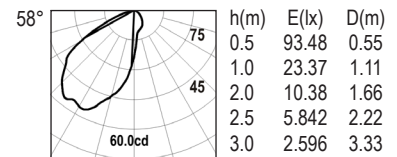

Optional Stainless Steel Louvers



- Horizontal front louvers of SS-304/aluminium Machined at an angle to provide glare free pathway Light
- Construction in single piece die-cast aluminium
- Recessed pre installation housing for concrete installation
- Silicone gasket for moisture protection
- Rubber H07RNF cable 0.5 mtr with cable gland
- All hardware in SS-304
- Toughened extra clear safety glass 3.2mm incorporated
- Polyester powder coated with high U.V. & corrosion resistance
- Extruded aluminium for better heatsink of LED
- Moisture control device to reduce misting on glass
- Wire for mains supply cable 3c×1.5mm²
- Reiz Electronic LED driver constant current integrated, THD<10% PF>0.95
- LED CRI : 85

Torrent S

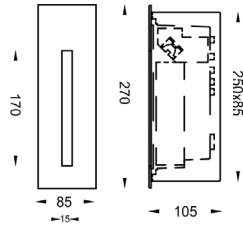

07403500301 ■ 001 ■ 500
 4W 385lm 6000K
 Cut Off Angle : 4° Optics : 31°
Led Color **Finish**
 C 6000K W White
 N 4000K B Black
 W 3000K S Silver

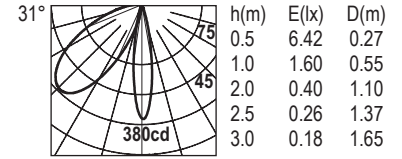

07403500801 ■ 001 ■ 500
 8W 760lm 6000K
 Cut Off Angle : 8° Optics : 45°
Led Color **Finish**
 C 6000K W White
 N 4000K B Black
 W 3000K S Silver

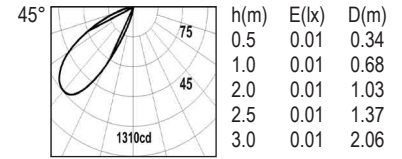

- Asymmetrical light distribution for giving a narrow shaft of light through the slit is used to mark passages and walkways
- Construction - front plate in electropolish SS-304 & housing in die cast aluminium
- Recessed pre installation housing for concrete installation
- Silicone gasket for moisture protection

- Rubber H07RNF cable 0.5 mtr with cable gland
- All hardware in SS-304
- Toughened extra clear safety glass 3.2mm incorporated
- Polyester powder coated with high U.V. & corrosion resistance
- Extruded aluminium for better heatsink of LED

- Moisture control device to reduce misting on glass
- Wire for mains supply cable 3c×1.5mm²
- Reiz Electronic LED driver constant current integrated, THD<10% PF>0.95
- LED CRI : 85

Torrent Diffuse

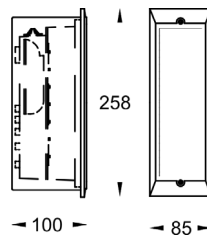

074D3300108 ■ 001 ■ 500
 8W 745lm 6000K
Led Color **Finish**
 C 6000K W White
 N 4000K B Black
 W 3000K S Silver

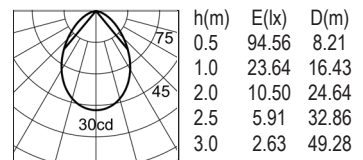

- Luminaire can be mounted in vertical or horizontal position to provide even diffused light output for illuminating pathways
- Construction in single piece die-cast aluminium
- Recessed pre installation housing for concrete installation
- Silicone gasket for moisture protection

- Rubber H07RNF cable 0.5 mtr with cable gland
- All hardware in SS-304
- Toughened extra clear safety glass 3.2mm incorporated
- Polyester powder coated with high U.V. & corrosion resistance

- Extruded aluminium for better heatsink of LED
- Wire for mains supply cable 3c×1.5mm²
- Reiz Electronic LED driver constant current integrated, THD<10% PF>0.95
- LED CRI : 85



DLF Cyber Hub -Gurgaon

CEILING RECESSED

Ease of installation for spas, sauna and wet areas. It comes in a range of diffused and spot glows and can be customised by color and optics.



Moonshine

Droplite Micro

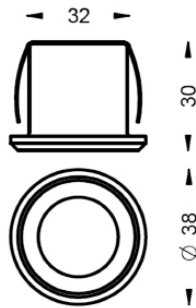

06720000201 **04500**
 3W 262lm 6000K
 Cut Off Angle : 25°

Led Color	Optics	Finish
C 6000K	12°	W White
N 4000K	24°	B Black
W 3000K	36°	S Silver

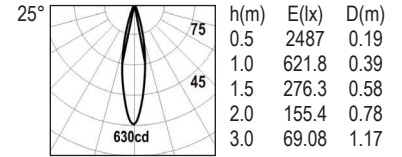

- Wall/ceiling recessed downlight as a marker/ accentuating light for LED lamps
- Construction in single pieces aluminium inner casing anodized for better heatsink
- Rubber H07RNF cable 0.5 mtr
- Top flange is electropolished in SS-304

- Toughened step extra clear safety glass 4mm is flushed with SS trim to avoid dirt contamination
- Extruded aluminium for better heatsink of LED
- Fixture holding system using stainless steel-304 fastening TRI clip
- False ceiling thickness 12 to 30mm

- Wire for mains supply cable 2c×1.5mm²
- IP-67 connector for cable O.D. 6-10mm can be ordered separately
- Reiz Electronic LED driver constant current remote, THD<10% PF>0.95
- LED CRI : 85

Moonshine

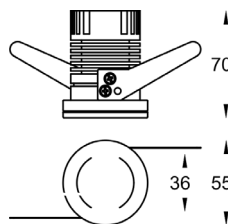

21418100104 **0W500**
 6W 521lm 6000K
 Cut off Angle : 30°

Led Color	Optics	Finish
C 6000K	12°	W White
N 4000K	24°	B Black
W 3000K	36°	S Silver

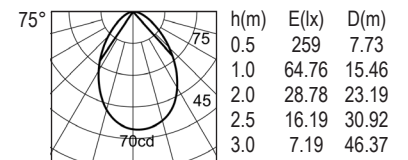

- Diffused LED fixed luminaires, ceiling & wall light for soft glow
- Construction in inner casing extruded aluminium anodized for better heatsink of LED
- Rubber H07RNF cable 0.5mtr with cable gland
- All hardware in SS-304

- Polycarbonate diffuser with high transmittance in 8mm thickness
- Fixture holding system using stainless steel-304 fastening wings
- False ceiling thickness 12 to 30mm
- IP-67 connector for cable O.D. 6-10mm can be

- ordered separately
- Wire for mains supply cable 2c×1.5mm²
- Mastic tape for water joint is provided
- Reiz Electronic LED driver constant current remote, THD<10% PF>0.95
- LED CRI : 85

Droplite Milli

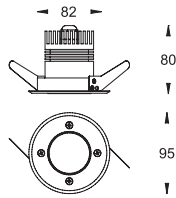

06920000801 14500

8W 702lm 6000K
Cut Off Angle : 12°

Led Color	Optics	Finish
C 6000K	12°	W White
N 4000K	24°	B Black
W 3000K	36°	S Silver

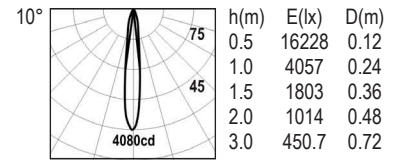

06920000204 04500

12W 1152lm 6000K
Cut Off Angle : 12°

Led Color	Optics	Finish
C 6000K	12°	W White
N 4000K	24°	B Black
W 3000K	36°	S Silver



- Spot LED fixed luminaires, ceiling light for spot downlighting for spas, sauna, wet areas.
- Construction in extruded aluminium for better heatsink of LED
- Rubber H07RNF cable 0.5mtr with cable gland
- All hardware in SS-304
- Top flange is electropolished in SS-304

- Anodized Aluminium with high U.V. & corrosion resistance
- Toughened step extra clear safety glass 8mm is flushed with SS trim to avoid dirt contamination
- Fixture holding system using stainless steel-304 fastening wings
- False ceiling thickness 12 to 30mm

- IP-67 connector for cable O.D. 6-10mm can be ordered separately
- Wire for mains supply cable 2c×1.5mm²
- Reiz Electronic LED driver constant current integrated, THD<10% PF>0.95
- LED CRI : 85

Droplite Maxx

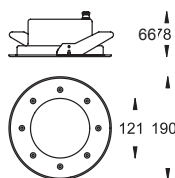

18520000112 14500

15W 1310lm 6000K
Cut Off Angle : 10°

Led Color	Optics	Finish
C 6000K	12°	W White
N 4000K	24°	B Black
W 3000K	36°	S Silver

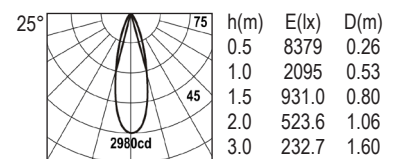

18520000212 14500

26W 2281lm 6000K
Cut Off Angle : 10°

Led Color	Optics	Finish
C 6000K	12°	W White
N 4000K	24°	B Black
W 3000K	36°	S Silver

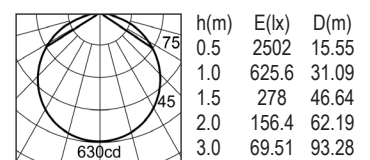

- Spot LED fixed luminaires, ceiling light for spot downlighting for spas, sauna, wet areas
- Extruded aluminium for better heatsink of LED
- Rubber H07RNF cable 0.5mtr with cable gland
- All hardware in SS-304
- Construction - inner casing in electropolished SS-304 to give long life & top flange in electropolished in SS-304/SS-316

- Toughened step extra clear safety glass 8mm is flushed with SS trim to avoid dirt contamination
- Fixture holding system using stainless steel-304 fastening wings
- False ceiling thickness 12 to 30mm
- IP-67 connector for cable O.D. 6-10mm can be ordered separately

- Wire for mains supply cable 2c×1.5mm²
- Reiz Electronic LED driver constant current integrated, THD<10% PF>0.95
- LED CRI : 85



The Kingsbury, Colombo

WALL RECESSED

An effective lighting solution for passages, corridors and walking areas. Easy to install, the LED color and finish can be personalised using LED Color and finish.



Keyhole 360

Keyhole 360

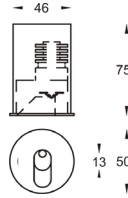
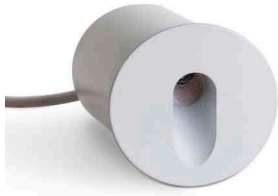

21200000101 000 500
 2W 179lm 6000K
 Cut Off Angle : 30° Optics : 45°
Led Color **Finish**
 C 6000K W White
 N 4000K B Black
 W 3000K S Silver

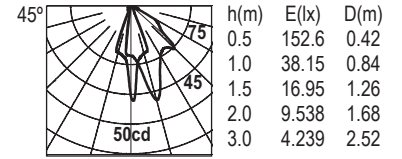

21200000201 000 500
 3W 269lm 6000K
 Cut Off Angle : 27° Optics : 45°
Led Color **Finish**
 C 6000K W White
 N 4000K B Black
 W 3000K S Silver

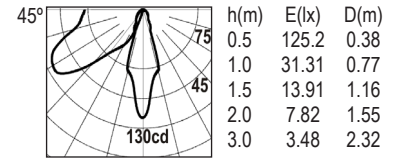

- Recessed floor washer LED for lighting up floor, passage, corridors
- Construction in extruded CNC machined aluminium
- Pre-mount housing for easy installation
- Rubber H07RNF cable 0.5mtr

- Polyester powder coated with high U.V. & corrosion resistance
- Fixture holding system using stainless steel-304 fastening springs
- Extruded aluminium for better heatsink of LED
- Strain relief cable clamp

- Wire for mains supply cable 2C×1.5mm²
- Reiz Electronic LED driver 24V DC remote, THD<10% PF>0.95
- LED CRI : 85

Keyhole

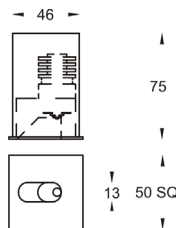
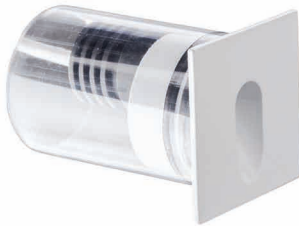

21300000101 000 200
 2W 182lm 6000K Led CRI : 85
 Cut Off Angle : 30° Optics : 30°
Led Color **Finish**
 C 6000K W White
 N 4000K B Black
 W 3000K S Silver

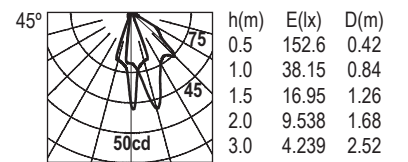

21300000201 000 500
 3W 268lm 6000K Led CRI : 85
 Cut Off Angle : 26° Optics : 26°
Led Color **Finish**
 C 6000K W White
 N 4000K B Black
 W 3000K S Silver

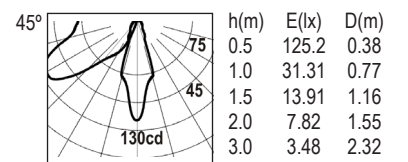

- Recessed floor washer LED for lighting up floor, passage, corridors
- Construction in extruded CNC machined aluminium
- Pre-mount housing for easy installation
- Rubber H07RNF cable 0.5mtr

- Polyester powder coated with high U.V. & corrosion resistance
- Fixture holding system using stainless steel-304 fastening springs
- Extruded aluminium for better heatsink of LED

- Strain relief cable clamp
- Wire for mains supply cable 2C×1.5mm²
- Reiz Electronic LED driver 24V DC remote, THD<10% PF>0.95
- LED CRI : 85

Smile

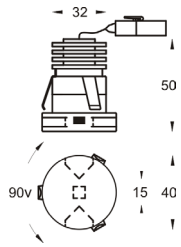

21100000201 ■ 000 ■ 200
 2W 187lm 6000K
 Cut Off Angle : 80° Optics : 180°
Led Color ■ **Finish**
 C 6000K ■ W White
 N 4000K ■ B Black
 W 3000K ■ S Silver

21100000301 ■ 000 ■ 200
 3W 282lm 6000K
 Cut Off Angle : 80°
Led Color ■ **Finish**
 C 6000K ■ W White
 N 4000K ■ B Black
 W 3000K ■ S Silver

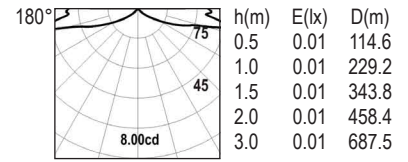

Photometric On Request



- Recessed updown LED luminaires for wide beam grazing light on walls, use in hotels & retail
- Construction in extruded CNC machined aluminium
- Polyester powder coated with high U.V. & corrosion resistance

- Fixture holding system using stainless steel-304 fastening springs
- Extruded aluminium for better heatsink of LED
- Strain relief cable clamp with quick connect LED harness

- Wire for mains supply cable 2C×1.5mm²
- Reiz Electronic LED driver 24V DC remote, THD<10%, PF>0.95
- LED CRI : 85



Smile
ITC, Grand Bharat, Manesar

WALL MOUNTED

A choice of modern lighting fixtures that are aesthetically designed. They come in diffuse and spot options to fit different usages and can be customised for LED color, optics and finish.



Peak

Barrel Acrylic

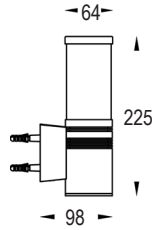

01403800801 001 500
 8W 762lm 6000K
 Cut Off Angle : 0° Optics : 180°
Led Color **Finish**
 C 6000K **W** White
 N 4000K **B** Black
 W 3000K **S** Silver

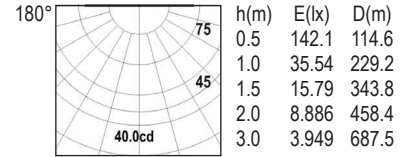

- Wall mounted luminaire for soft diffused symmetrical light for corridors using LED lamps
- Construction in extruded aluminum pipe and polycarbonate OPAL diffuser
- Polyester powder coated with high U.V. & corrosion resistance

- Silicone gasket for moisture protection
- Fixture holding system using stainless steel-304 fastening screws
- All hardware is SS-304
- Extruded aluminium for better heatsink of LED
- Strain relief cable clamp with terminal block

- Wire for mains supply cable 3x1.5mm²
- Reiz Electronic LED driver constant current integrated, THD<10% PF>0.95
- LED CRI : 85

Peak

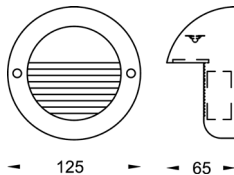

15900000201 901 500
 3W 268lm 6000K
 Cut Off Angle : 45° Optics : 84°
Led Color **Finish**
 C 6000K **W** White
 N 4000K **B** Black
 W 3000K **S** Silver

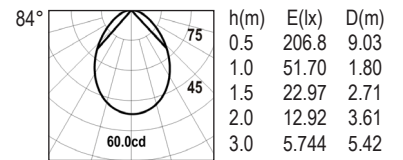

15900000801 901 500
 8W 780lm 6000K
 Cut Off Angle : 45° Optics : 84°
Led Color **Finish**
 C 6000K **W** White
 N 4000K **B** Black
 W 3000K **S** Silver

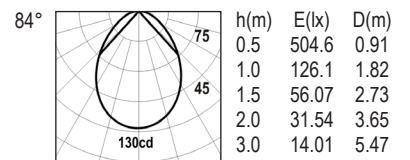

- Wall mounted luminaire use in entrances, driveways, walkways and corridors for wall wash applications
- Construction in die-cast aluminium
- Polyester powder coated with high U.V. & corrosion resistance

- Toughened extra clear safety glass 3.2mm incorporated
- Silicone gasket for moisture protection
- Fixture holding system using stainless steel-304 fastening screws
- All hardware is SS-304

- Extruded aluminium for better heatsink of LED
- Strain relief cable clamp with terminal block
- Wire for mains supply cable 3x1.5mm²
- Reiz Electronic LED driver constant current integrated, THD<10% PF>0.95
- LED CRI : 85

Barrel Copper

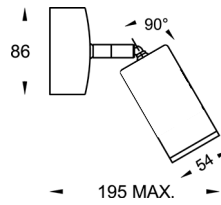

1210000204 **1C500**
 12W 1184lm 6000K
 Cut Off Angle : 30°

Led Color	Optics	Finish
C 6000K	12°	W White
N 4000K	24°	B Black
W 3000K	36°	S Silver

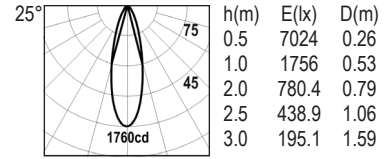

- Wall mounted luminaire for spot light using LED lamps for corridors, bathrooms, walkways
- Construction in copper for natural tarnished vintage look
- Toughened extra clear safety glass 3.2mm incorporated

- Silicone gasket for moisture protection
- All hardware is SS-304
- Extruded aluminium for better heatsink of LED
- Strain relief cable clamp with terminal block

- Wire for mains supply cable 3c×1.5mm²
- Reiz Electronic LED driver constant current integrated, THD<10% PF>0.95
- LED CRI : 85

Double Barrel Copper

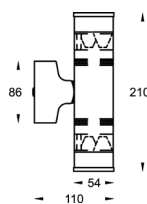

1220000208 **1C500**
 18W 1601lm 6000K
 Cut Off Angle : 30°

Led Color	Optics	Finish
C 6000K	12°	W White
N 4000K	24°	B Black
W 3000K	36°	S Silver

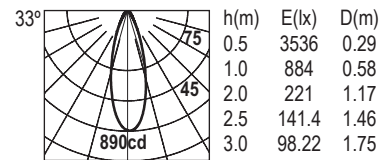

- Wall mounted luminaire for updown spotlighting to accentuate pillars, columns, walls using LED lamps
- Construction in copper for natural tarnished vintage look

- Toughened extra clear safety glass 3.2mm incorporated
- Silicone gasket for moisture protection
- All hardware is SS-304
- Extruded aluminium for better heatsink of LED

- Strain relief cable clamp with terminal block
- Wire for mains supply cable 3c×1.5mm²
- Reiz Electronic LED driver constant current integrated, THD<10% PF>0.95
- LED CRI : 85

Barrel

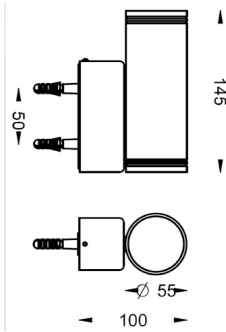

01401700601 1 600
 6 W 570lm 6000K
 Cut Off Angle : 30°
 Led Color Optics Finish
 C 6000K 12° W White
 N 4000K 24° B Black
 W 3000K 36° S Silver



01401700204 1 500
 8 W 748lm 6000K
 Cut Off Angle : 30°
 Led Color Optics Finish
 C 6000K 12° W White
 N 4000K 24° B Black
 W 3000K 36° S Silver

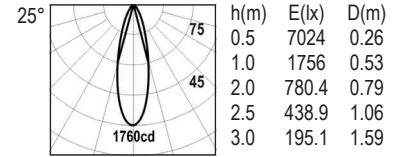

01401700204 1 500
 12 W 1109lm 6000K
 Cut Off Angle : 30°
 Led Color Optics Finish
 C 6000K 12° W White
 N 4000K 24° B Black
 W 3000K 36° S Silver



- Wall mounted luminaire for downlight light using LED lamps for corridors, walkways.
- Construction in extruded aluminium.
- Rectangular base for wall mounting.
- Tempered safety glass 3.2mm.

- Silicone gasket for moisture protection.
- Integrated strain relief cable clamp with terminal block.
- Extruded aluminium for better heatsink of LED

- Reiz Electronic LED driver constant current integrated, THD<10% PF>0.95
- LED CRI : 85

Double Barrel

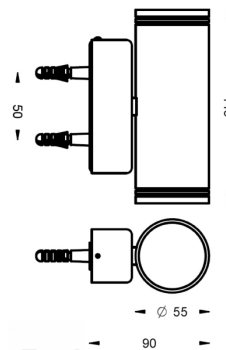

0140700208 1 500
 18 W 1686lm 6000K
 Cut Off Angle : 30°
 Led Color Optics Finish
 C 6000K 12° W White
 N 4000K 24° B Black
 W 3000K 36° S Silver

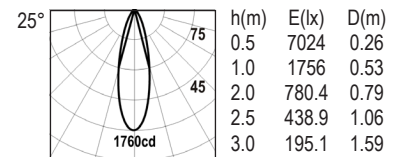

- Wall mounted luminaire for spotlighting Up & Down to accentuate pillars, columns & walls
- Single piece, screwless construction in extruded aluminium.
- Tempered safety glass at both ends 3.2mm.

- Silicone gasket for moisture protection.
- Integrated strain relief cable clamp with terminal block.
- Extruded aluminium for better heatsink of LED

- Reiz Electronic LED driver constant current integrated, THD<10% PF>0.95
- LED CRI : 85

Barrel Maxx

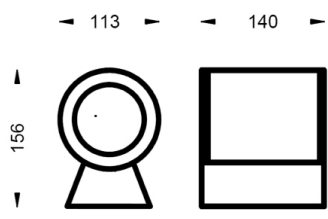

02701300112 1 500
 15W 1275lm 6000K
 Cut Off Angle : 20°
Led Color **Optics** **Finish**
 C 6000K 12° W White
 N 4000K 24° B Black
 W 3000K 36° S Silver

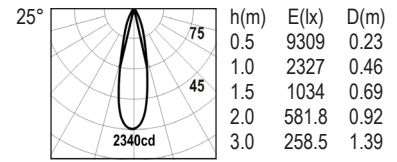

02701300212 1 500
 26W 2106lm 6000K
 Cut Off Angle : 20°
Led Color **Optics** **Finish**
 C 6000K 12° W White
 N 4000K 24° B Black
 W 3000K 36° S Silver



- Wall mounted down spotlighting to accentuate pillars, columns, walls
- Construction in extruded and die-cast aluminium
- Polyester powder coated with high U.V. & corrosion resistance
- Toughened extra clear safety glass 3.2mm incorporated

- Silicone gasket for moisture protection
- Fixture holding system using stainless steel-304 fastening brackets
- All hardware is SS-304
- Moisture control device to reduce misting on glass

- Strain relief cable clamp with terminal block
- Wire for mains supply cable 3c×1.5mm²
- Reiz Electronic LED driver constant current integrated, THD<10% PF>0.95
- LED CRI : 85

Double Barrel Maxx

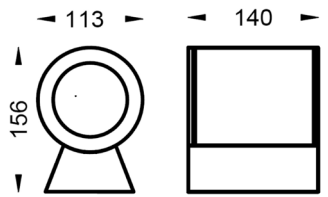

02701300124 1 500
 26W 2132lm 6000K
 Cut Off Angle : 20°
Led Color **Optics** **Finish**
 C 6000K 12° W White
 N 4000K 24° B Black
 W 3000K 36° S Silver

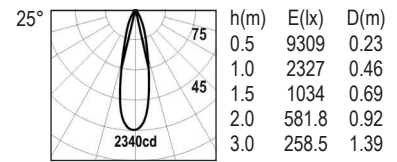

02701300224 1 500
 50W 4108lm 6000K
 Cut Off Angle : 20°
Led Color **Optics** **Finish**
 C 6000K 12° W White
 N 4000K 24° B Black
 W 3000K 36° S Silver

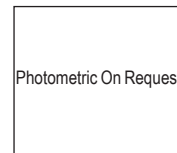

- Wall mounted up down spotlighting for facade to accentuate pillars, columns, walls
- Construction in extruded and die-cast aluminium
- Polyester powder coated with high U.V. & corrosion resistance
- Toughened extra clear safety glass 3.2mm incorporated

- Silicone gasket for moisture protection
- Fixture holding system using stainless steel-304 fastening brackets
- All hardware is SS-304
- Moisture control device to reduce misting on glass

- Strain relief cable clamp with terminal block
- Wire for mains supply cable 3c×1.5mm²
- Reiz Electronic LED driver constant current integrated, THD<10% PF>0.95
- LED CRI : 85

Lance

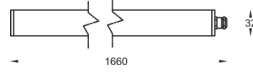

148000R272 **001** **500**

20W 2100lm 6000K
Cut off Angle : 5°

Led Color	Finish
C 6000K	W White
N 4000K	B Black
W 3000K	S Silver

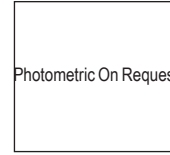

- Wall mounted luminaire for exterior applications for use in entrances, walkways and covers
- Construction in PMMA diffuser & extruded aluminium
- Reflector aluminium 99.9% silver bright anodized
- Polyester powder coated with high U.V. & corrosion resistance

- Rubber H07RMF cable 0.5mtr with cable gland
- Silicone gasket for moisture protection
- Fixture holding system using polycarbonate fastening brackets
- All hardware is SS-304

- Strain relief cable clamp with terminal block
- Mains supply cable upto 2c×1.5mm²
- Reiz Electronic LED driver constant current integrated, THD<10% PF>0.95
- LED CRI : 85

Light House

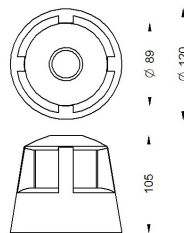

232038008003001W500
8W 705lm 6000K

Led Color	Finish
C 6000K	W White
N 4000K	B Black
W 3000K	S Silver

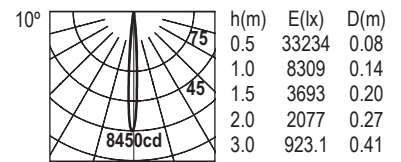

- Wall mounted luminaire use in entrances, driveways, walkways and corridors for wall wash applications
- Construction in die-cast aluminium
- Polyester powder coated with high U.V. & corrosion resistance

- Silicone gasket for moisture protection
- Fixture holding system using stainless steel-304 fastening screws
- All hardware is SS-304
- Extruded aluminium for better heatsink of LED
- Strain relief cable clamp with terminal block

- Wire for mains supply cable 3c×1.5mm²
- Reiz Electronic LED driver constant current integrated, THD<10% PF>0.95
- LED CRI : 80

Dart

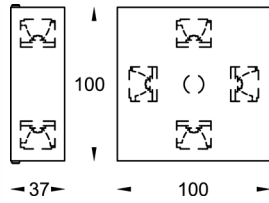

2150000202 101S5
 5W 392lm 6000K
 Cut Off Angle : 20°

Led Color	Finish
C 6000K	W White
N 4000K	B Black
W 3000K	S Silver
B Blue	

2150000204 101S5
 10W 990lm 6000K
 Cut off Angle : 20°

Led Color	Finish
C 6000K	W White
N 4000K	B Black
W 3000K	S Silver
B Blue	

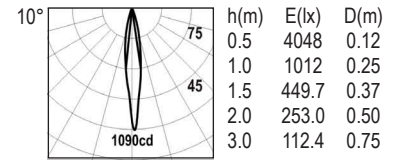
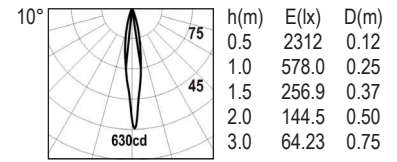

- Surface mounted LED luminaires with narrow beam for use in for creating patterns
- Construction in extruded anodized aluminium for better heatsink of LED
- Narrow Beam optics of 10°

- Toughened extra clear safe glass 3.2mm
- Silicone gasket for moisture protection
- Fixture holding system using stainless steel-304 fastening brackets
- All hardware is SS-304

- Mains supply cable upto 2c×1.5mm²
- Reiz Electronic LED driver constant current integrated, THD<10% PF>0.95
- LED CRI : 85

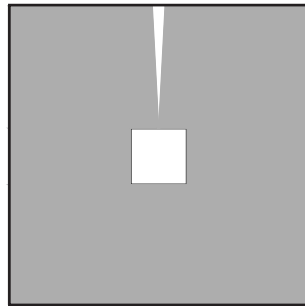

00 Dart Uno 3W

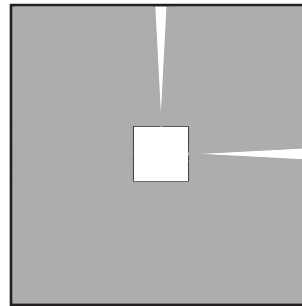

0L Dart L 5W

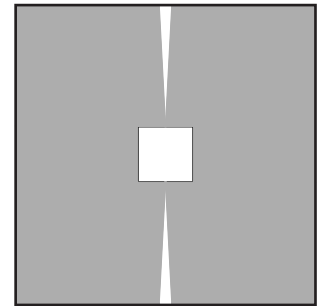

SD Dart Duo 5W

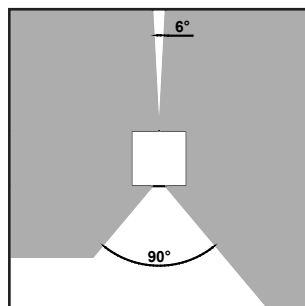

0Y Dart Y 5W

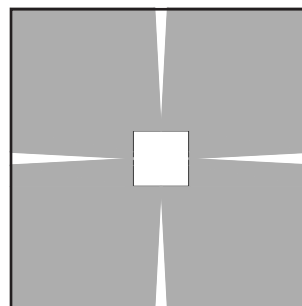

SQ Dart Quad 10W

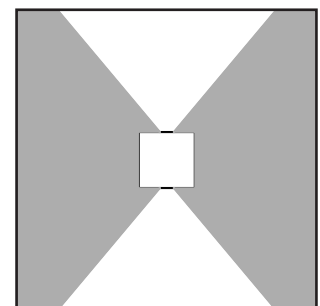

0X Dart X 5W

Aqua

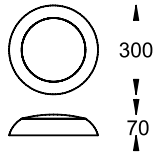

1860000212 0 800
 15W 1295lm 6000K
 Cut Off Angle : 6°

Led Color	Optics	Finish
C 6000K	12°	W White
N 4000K	24°	B Black
W 3000K	36°	S Silver

1860000212 0 800
 26W 2158lm 6000K
 Cut Off Angle : 6°

Led Color	Optics	Finish
C 6000K	12°	W White
N 4000K	24°	B Black
W 3000K	36°	S Silver

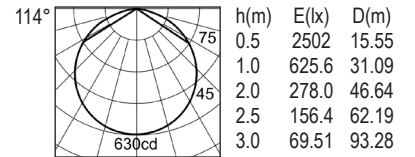
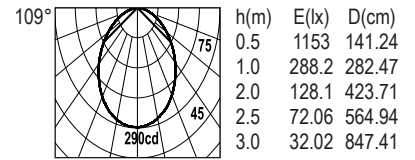

- Surface mounted pool light for mounting onto concrete surface
- Asymmetrical lens available optional to direct the light towards bottom of the pool
- Construction - inner casing in electropolished SS-316 to give long life & top flange in electropolished in SS-304/SS-316

- Double silicone gasket for moisture protection
- Rubber H07RNF cable 3mtr with cable gland
- Toughened step extra clear safety glass 12mm incorporated
- Stainless steel for better heatsink of LED
- Moisture control device to reduce misting on glass

- Wire for mains supply cable 2c×1.5mm²
- Reiz Electronic LED driver constant current integrated, THD<10% PF>0.95
- LED CRI : 85

Pygmy

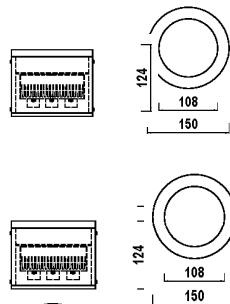

0190000112 1 500
 15W 1275lm 6000K
 Cut Off Angle : 15°

Led Color	Finish
C 6000K	W White
N 4000K	B Black
W 3000K	S Silver

0190000212 1 500
 26W 2158lm 6000K

Led Color	Finish
C 6000K	W White
N 4000K	B Black
W 3000K	S Silver

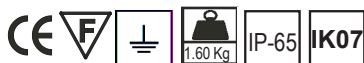
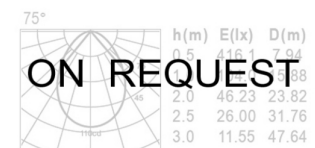
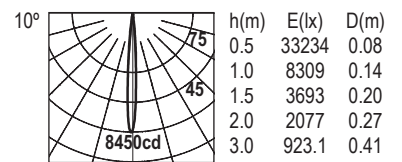

- Surface mounted luminaire use in entrances, driveways, walkways, porches and corridors
- Construction in extruded aluminium and 85% transmittance PMMA OPAL diffuser/ toughened extra clear safety glass 3.2mm incorporated
- Polyester powder coated with high U.V. & corrosion resistance

- Silicone gasket for moisture protection
- Fixture holding system using stainless steel-304 fastening screws
- All hardware is SS-304
- Extruded aluminium for better heatsink of LED
- Strain relief cable clamp with terminal block

- Wire for mains supply cable 3c×1.5mm²
- Reiz Electronic LED driver constant current integrated, THD<10% PF>0.95
- LED CRI : 85

Glo Micro

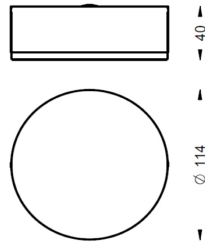

001032010W0 001 300
20W 2100lm 6000K

Led Color	Finish
C 6000K	W White
N 4000K	B Black
W 3000K	S Silver

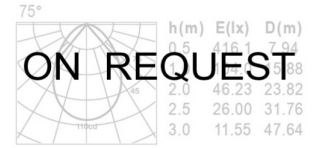

- Wall mounted luminaire for exterior applications for use in entrances, walkways and coves
- Construction in PMMA diffuser & extruded aluminium
- Reflector aluminium 99.9% silver bright anodized
- Polyester powder coated with high U.V. & corrosion resistance

- Silicone gasket for moisture protection
- Fixture holding system using polycarbonate fastening brackets
- All hardware is SS-304
- Strain relief cable clamp with terminal block

- Mains supply cable upto 2c×1.5mm²
- Reiz Electronic LED driver constant current integrated, THD<10% PF>0.95
- LED CRI : 85

Kan Micro

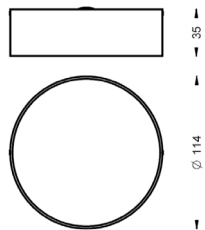

001032008W0 KM1 300
10W 1121lm 6000K

Led Color	Finish
C 6000K	W White
N 4000K	B Black
W 3000K	S Silver

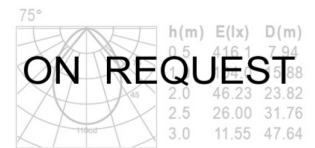

- Low Profile Surface mounted medium beam distribution luminaires for ambient lighting for lobbies, entrances, corridors, porche s etc.
- Construction in Extrusion aluminium.

- Bracket mounts on a key slot mechanism.
- Powder coated with high U.V. & corrosion resistance.
- Extruded aluminium for better heat sink of LED
- Strain relief rubber EPDM grommet cable clamp.

- Wire for mains supply cable up to 2c×1.5mm².
- Reiz energy saving LED driver is integrated, THD<10%, PF>0.95%.

Glo Mini

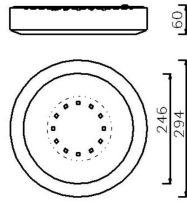

001032015W0 ■ 001 ■ 300
 15W 1440lm 6000K
 Optics : 100°

Led Color	Finish
C 6000K	W White
N 4000K	B Black
W 3000K	S Silver

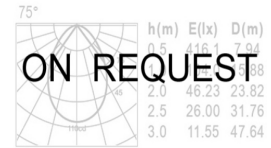

001032024W0 ■ 001 ■ 300
 24W 2310lm 6000K
 Optics : 100°

Led Color	Finish
C 6000K	W White
N 4000K	B Black
W 3000K	S Silver

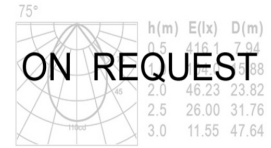

- The glo mini is made Surface mounted full glow distribution luminaires for ambient lighting for lobbies, entrances, corridors, porches etc.
- Construction in extruded aluminium housing
- High efficiency PMMA diffuser.

- White diffuser for 98% reflectance
- Extruded aluminium for better heatsink of LED
- Strain relief cable clamp with quick connect LED harness

- Wire for mains supply cable 2c×1.5mm²
- Reiz Electronic LED driver constant current integrated, THD<10%, PF>0.95
- LED CRI : 85

Kan Mini

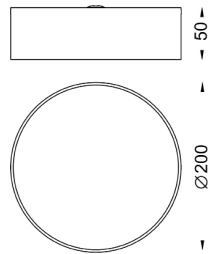

07106400112 ■ 001 ■ 3DF
 15W 1440lm 6000K
 Optics : 100°

Led Color	Finish
C 6000K	W White
N 4000K	B Black
W 3000K	S Silver

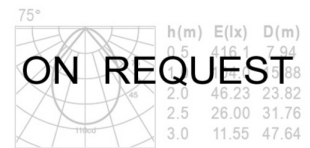

07106400112 ■ 001 ■ 3DF
 24W 2610lm 6000K
 Optics : 100°

Led Color	Finish
C 6000K	W White
N 4000K	B Black
W 3000K	S Silver

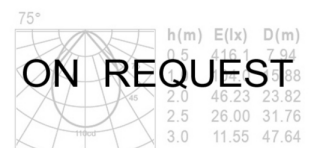

- Surface mounted luminaire for medium beam distribution for ambient lighting for lobbies, entrances, corridors etc.
- Construction in single piece, screw less in pure aluminium.
- Surface mounted luminaire for vertical lamp configuration.

- Polyester powder coated with high U.V. & corrosion resistance.
- Extruded aluminium for better heat sink of LED.
- Quick connect LED harness.
- Strain relief cable clamp
- Wire for mains supply cable up to 2c×1.5mm².

- Reiz energy saving LED driver is integrated THD<10% PF>0.95%.
- LED CRI :80

Up Light

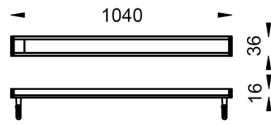
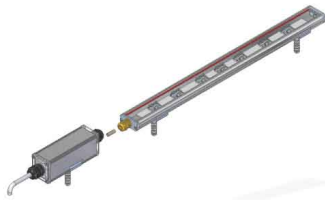

2620000114 ■ 001 ■ 500
 15W 1780lm 6000K
 Optics : 100°

Led Color	Finish
C 6000K	W White
N 4000K	B Black
W 3000K	S Silver

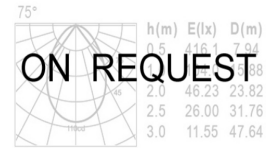

- Wall Mounted up light for LED for indirect lighting.
- Inner casing is one piece ss-304/316 electro polished to give long life
- Silicone gasket design for moisture protection.

- Toughened step extra clear safety polycarbonate
- Double powder coated with high U.V. resistance & corrosion resistance.
- High temperature rubber cable 3Cx0.5mm sq. H07RNF

- Extruded aluminium for better heatsink of LED
- Reiz Electronic LED driver constant current integrated, THD<10%, PF>0.95, LED CRI : 85
- LED are driven with active current control circuit

PROJECTOR LUMINAIRES

Luminaires that can be fixed in different directions throwing a beam of light for versatile lighting options. Its sturdy construct and design ensures repeated adjustability and customising options for LED color, optics and finish allows you to personalise the look.



Beamer Hoody

Beamer Micro

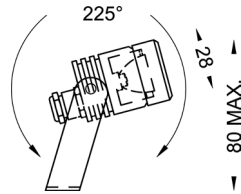

06703400101 0 0 00
 2W 172lm 6000K
 Cut Off Angle : 20°

Led Color	Optics	Finish
C 6000K	12°	W White
N 4000K	24°	B Black
W 3000K	36°	S Silver

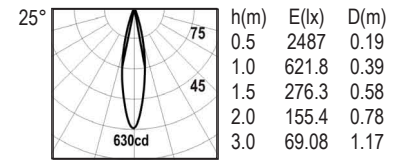

06703400201 0 0 00
 3W 255lm 6000K
 Cut Off Angle : 20°

Led Color	Optics	Finish
C 6000K	12°	W White
N 4000K	24°	B Black
W 3000K	36°	S Silver

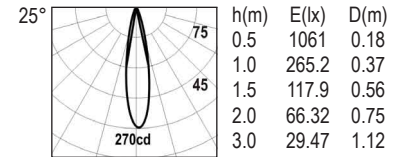

- Compact floor mounted light as an accentuating light for LED lamps with an adjustable stirrup ±225°
- Construction in single piece electropolish SS-304/SS-316 for better heatsink
- Top cover is electropolished in SS-304/SS-316 to give long life

- Silicone gasket for moisture protection
- Fixture holding system using SS-304/SS-316 fastening brackets
- Toughened step extra clear safety glass 4mm is flushed with SS trim to avoid dirt contamination
- Rubber H07RNF cable length for IP-67 = 1mtr, for IP-68 = 2mtr with gland

- Additional cable length to be ordered separately
- Wire for mains supply cable 2c×1.5mm²
- IP-68 connector for cable O.D. 6-10mm
- Reiz Electronic LED driver 24V DC remote, THD<10% PF>0.95
- LED CRI : 85

Beamer Milli

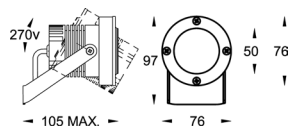

06903400204 0 0 00
 12W 1005lm 6000K
 Cut Off Angle : 12°

Led Color	Optics	Finish
C 6000K	12°	W White
N 4000K	24°	B Black
W 3000K	36°	S Silver

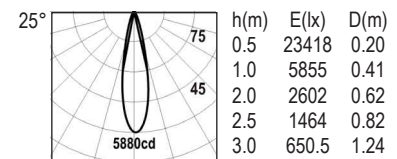

06903400207 0 0 00
 16W 1425lm 6000K
 Cut Off Angle : 25°

Led Color	Optics	Finish
C 6000K	12°	W White
N 4000K	24°	B Black
W 3000K	36°	S Silver

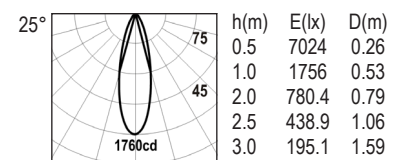

- Compact floor mounted light as a diffused/spot LED directional luminaries with an adjustable stirrup 225°
- Construction in extruded aluminium for better heatsink of LED
- Top cover is electropolished in SS-304/SS-316 to give long life
- All hardware in SS-304

- Double silicone gasket for moisture protection
- Fixture holding system using SS-304/SS-316 fastening brackets
- Toughened step extra clear safety glass 8mm is flushed with SS trim to avoid dirt contamination
- Rubber H07RNF cable length for IP-67 = 1mtr, for IP-68 = 3mtr with gland

- Additional cable length to be ordered separately
- Wire for mains supply cable 2c×1.5mm²
- IP-68 connector for cable O.D. 6-10mm
- Reiz Electronic LED driver 24V DC remote, THD<10% PF>0.95
- LED CRI : 85

Beamer Mini

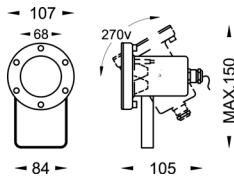

08503400204 0 00
 12W 1090lm 6000K
 Cut Off Angle : 20°
 Led Color Optics Finish
 C 6000K 12° W White
 N 4000K 24° B Black
 W 3000K 36° S Silver

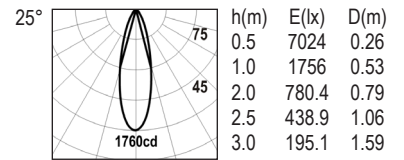

08503400207 0 00
 16W 1425lm 6000K
 Led Color Optics Finish
 C 6000K 12° W White
 N 4000K 24° B Black
 W 3000K 36° S Silver

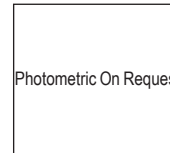

- Compact floor mounted light as a spot LED directional luminaires with an adjustable stirrup 225°
- Construction - inner casing & top flange in electropolished SS-304/SS-316 to give long life
- All hardware in SS-304
- Double silicone gasket for moisture protection

- Toughened step extra clear safety glass 10mm is flushed with SS trim to avoid dirt contamination
- Extruded aluminium for better heatsink of LED
- Fixture holding system using SS-304/SS-316 fastening brackets
- Rubber H07RNF cable length for IP-67 = 1mtr, for IP-68 = 2mtr with gland

- Additional cable length to be ordered separately
- Wire for mains supply cable 2x1.5mm²
- IP-68 connector for cable O.D. 6-10mm
- Reiz Electronic LED driver constant current remote, THD<10% PF>0.95
- LED CRI : 85

Beamer Maxx

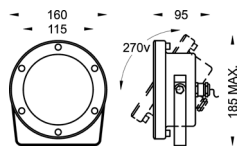

18503400112 0 00
 15W 1280lm 6000K
 Cut Off Angle : 11°
 Led Color Optics FINISH
 C 6000K 12° SS304
 N 4000K 24°
 W 3000K 36°
 X RGB

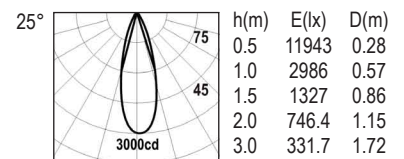

18503400212 0 00
 26W 2230lm 6000K
 Cut Off Angle : 12°
 Led Color Finish
 C 6000K SS304
 N 4000K
 W 3000K
 X RGB

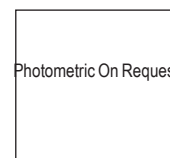

RGBW available with DMX Controller



- Compact floor mounted light as a spot LED with an adjustable stirrup 225°
- Construction - inner casing & top flange in electropolished SS-304/SS-316 to give long life
- All hardware in SS-304
- Double silicone gasket for moisture protection
- Toughened step extra clear safety glass 12mm is flushed with SS trim to avoid dirt contamination

- Extruded aluminium for better heatsink of LED
- Fixture holding system using stainless steel-304/SS-316 fastening brackets
- Selfresetting thermal protection device to protect unit from over heating
- Moisture control device to reduce misting on glass
- Rubber H07RNF cable length for IP-67 = 1mtr, for IP-68 = 3mtr with gland

- Additional cable length to be ordered separately
- Wire for mains supply cable 3x1.5mm²
- IP-68 connector for cable O.D. 6-10mm
- Reiz Electronic LED driver constant current remote, THD<10% PF>0.95
- LED CRI : 85

Beamer Hoody

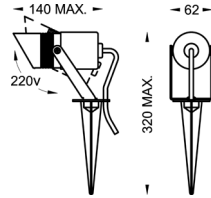

01412900801 1 5
 8W 710lm 2700K
 Cut Off Angle : 40°

Led Color	Optics	Finish
C 6000K	12°	W White
N 4000K	24°	B Black
W 3000K	36°	S Silver

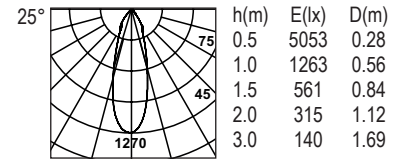

01412900204 1 5
 12W 1090lm 4000K
 Cut Off Angle : 40°

Led Color	Optics	Finish
C 6000K	12°	W White
N 4000K	24°	B Black
W 3000K	36°	S Silver

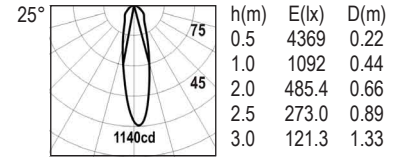

- Surface/spike mounted uplighter for highlighting columns, corner structures using lamps
- Construction in extruded aluminium
- Polyester powder coated with high U.V. & corrosion resistance
- Silicone gasket for moisture protection

- Toughened extra clear safe glass 3.2mm
- Extruded aluminium for better heatsink of LED
- All hardware is SS-304
- Earth mounted spike in corrosion resistant polycarbonate
- Rubber H07RNF cable 0.5mtr with cable gland

- Adjustable luminaires 220°, with micro adjustable at 15°
- Mains supply cable upto 3c×1.5mm²
- Reiz Electronic LED driver constant current integrated, THD<10% PF>0.95
- LED CRI : 85

Beamer Torch

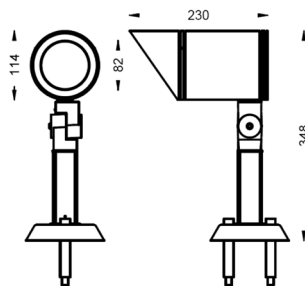

00105402001 601 500
 30W 2690lm 6000K

Led Color	Optics	Finish
C 6000K	12°	W White
N 4000K	24°	B Black
W 3000K	36°	S Silver

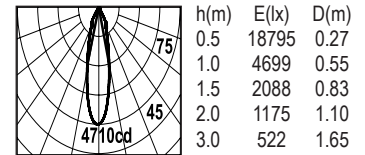

- Powerful Surface mounted adjustable luminaire for focusing pillars & walls
- Construction in die-cast aluminium
- Polyester powder coated with high U.V. & corrosion resistance

- Silicone gasket for moisture protection
- All hardware is SS-304
- HR PVC cable 0.5mtr with cable gland
- Strain relief cable clamp
- Adjustable luminaires 220°

- Mains supply cable upto 3c×1.5mm²
- Reiz Electronic LED driver constant current integrated, THD<10% PF>0.95
- LED CRI : 85

Color Washer

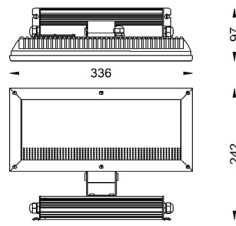
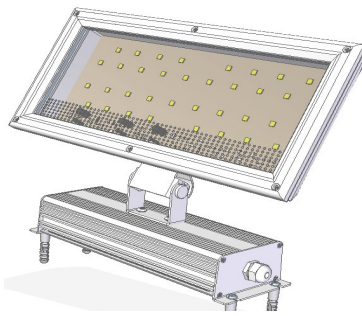

22122104336 000 500
 43W 3680lm 6000K
 Cut off Angle : 10°
Led Color
 C 6000K
 N 4000K
 W 3000K
Finish
 W White
 B Black
 S Silver

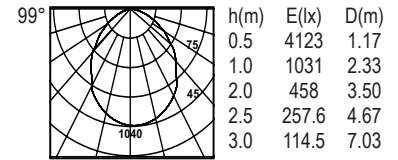

- Surface mounted directional luminaires for flood lighting using high power LED/RGB ColorLED mixing for applications such as highlighting fountains, ponds or facades
- It can be controlled in standalone mode or via single color REIZ controllers or via DMX controllers
- DMX slaves are integrated within the fixture with slave address shown digitally
- Adjustable light angle upto 180° is preset using screws on knuckle joint

- Construction in die-cast/extruded aluminium for better heatsink of LED
- All hardware is SS-304
- Polyester powder coated with high U.V. & corrosion resistance
- Silicone gasket for moisture protection
- High temperature 4 core data cable for DMX loop in/out
- Toughened stepped extra clear safety glass 8mm

- Strain relief cable clamp with terminal block with loop in/out connectors
- Transformer supply cable upto 4c×1.5mm²
- Quick connect LED harness with IP-68 connector integrated for cable O.D. 6-10 mm
- Reiz Electronic LED driver constant current integrated, THD<10% PF>0.95
- LED CRI : 85

Color Spray

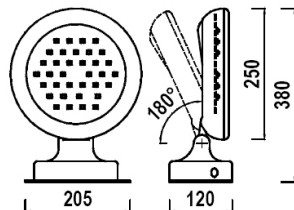

22022000136 0 500
 43W 2690lm 6500K
Led Color
 C 6000K
 N 4000K
 W 3000K
Finish
 W White
 B Black
 S Silver

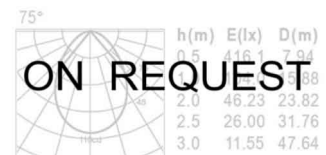

- Powerful Surface mounted adjustable luminaire for focusing pillars & walls
- Construction in die-cast aluminium
- Polyester powder coated with high U.V. & corrosion resistance

- Silicone gasket for moisture protection
- All hardware is SS-304
- HR PVC cable 0.5mtr with cable gland
- Strain relief cable clamp
- Adjustable luminaires 220°

- Mains supply cable upto 3c×1.5mm²
- Reiz Electronic LED driver constant current integrated, THD<10% PF>0.95
- LED CRI : 85



Infosys Bangalore Campus

Kendo

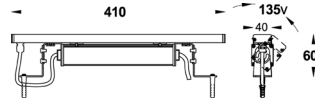

2620000207 ■ 901 ■ 500

16W 1510lm 6000K
Cut Off Angle : 52°

Led Color	Optics	Finish
C 6000K	12°	W White
N 4000K	24°	B Black
W 3000K	36°	S Silver

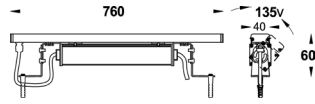
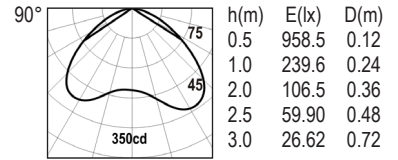

26000000214 ■ 901 ■ 500

32W 3010lm 6000K

Led Color	Finish
C 6000K	W White
N 4000K	B Black
W 3000K	S Silver

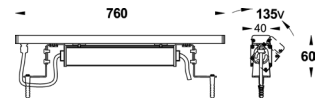

26000000221 ■ 901 ■ 500

46W 4310lm 6000K

Led Color	Finish
C 6000K	W White
N 4000K	B Black
W 3000K	S Silver

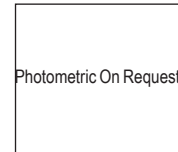

- Surface mounted low profile directional luminaire for highlighting, wall washing
- Construction in extruded aluminium
- Rubber H07RMF cable, gasket and polycarbonate diffuser incorporated
- Small footprint adjustable mounting bracket tilt 0-90°

- Polyester powder coated with high U.V. & corrosion resistance
- Wiring Harness of 1 meter or 2 meter can be ordered for easy looping of Lights.
- Extruded aluminium for better heatsink of LED
- IP-67 connector for cable O.D. 6-10mm

- Wire for mains supply cable 2C×1.5mm²
- Reiz Electronic LED driver constant current integrated, THD<10% PF>0.95
- LED CRI : 85

Directrix

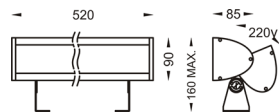

11700000107 ■ 1 ■ 500

16W 1505lm 6000K

Led Color	Finish
C 6000K	W White
N 4000K	B Black
W 3000K	S Silver

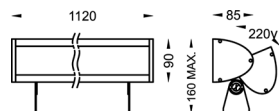
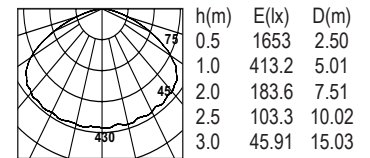

11700000121 ■ 1 ■ 500

24W 2250lm 6000K

Led Color	Finish
C 6000K	W White
N 4000K	B Black
W 3000K	S Silver

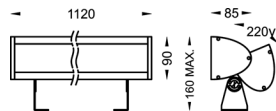
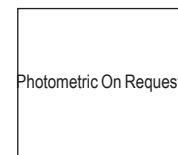

11800000115 ■ 1 ■ 500

40W, 3680lm RGBW

Led Color	Finish
C 6000K	W White
N 4000K	B Black
W 3000K	S Silver

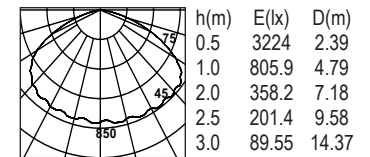

- Surface mounted outdoor directional light for highlighting, wall washing
- Gasket of high temperature silicone
- Polyester powder coated with high U.V. & corrosion resistance
- Small footprint adjustable mounting bracket 220°

- Wiring Harness of 1 meter or 2 meter can be ordered for easy looping of Lights.
- Extruded aluminium for better heatsink of LED
- Toughened extra clear safe glass 5mm
- Wire for mains supply cable 3c×1.5mm²
- IP-67 connector provided cable O.D. 6-10mm

- With RGBW option DMX 4 channel slave along with constant current LED Driver is integrated within the directions
- Reiz Electronic LED driver constant current integrated, THD<10% PF>0.95
- LED CRI : 85

Linear

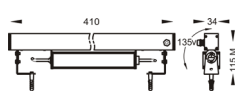
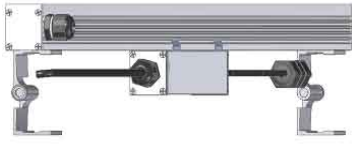

1770000107 ■ 1 ■ 5DR
8W 790lm 6000K LED CRI : 85

Led Color	Finish
C 6000K	W White
N 4000K	B Black
W 3000K	S Silver

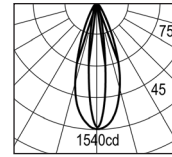

h(m)	E(x)	D(m)
0.5	2487	0.19
1.0	621.8	0.39
1.5	276.3	0.58
2.0	155.4	0.78
3.0	69.08	1.17

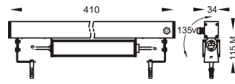

1770000207 ■ 1 ■ 5DR
16W 1530lm 6000K LED CRI : 85

Led Color	Finish
C 6000K	W White
N 4000K	B Black
W 3000K	S Silver

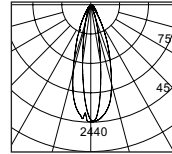

h(m)	E(x)	D(m)
0.5	9730	0.32
1.0	2432	0.65
1.5	1081	0.98
2.0	608	1.31
3.0	207	1.97

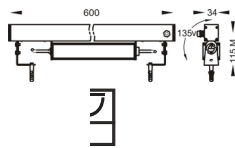

1760000115 ■ 1 ■ 5DR
20W, RGB

Led Color	Finish
C 6000K	W White
N 4000K	B Black
W 3000K	S Silver

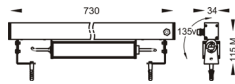
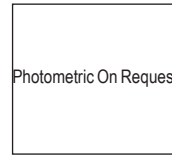

1760000114 ■ 1 ■ 5DR
16W 1510lm 6000K LED CRI : 85

Led Color	Finish
C 6000K	W White
N 4000K	B Black
W 3000K	S Silver

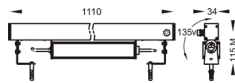

1710000121 ■ 1 ■ 5DR
24W 2380lm 6000K LED CRI : 85

Led Color	Finish
C 6000K	W White
N 4000K	B Black
W 3000K	S Silver

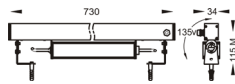
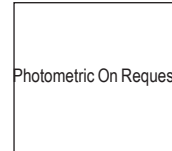

1760000214 ■ 1 ■ 5DR
24W 2380lm 6000K LED CRI : 85

Led Color	Finish
C 6000K	W White
N 4000K	B Black
W 3000K	S Silver

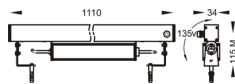
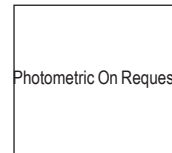

1710000132 ■ 1 ■ 5DR
40W 3810lm RGB

Led Color	Finish
C 6000K	W White
N 4000K	B Black
W 3000K	S Silver

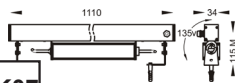
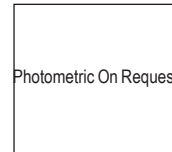

1710000221 ■ 1 ■ 5DR
46W 4390lm 6000K LED CRI : 85

Led Color	Finish
C 6000K	W White
N 4000K	B Black
W 3000K	S Silver

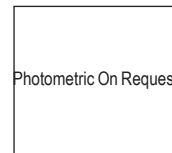

- Surface mounted outdoor fixed/directional light for highlighting, wall washing. Linear ledge is available on request with wide beam optics of 10/100 degrees for highlighting window sill.
- Construction in extruded aluminium for better heatsink of LED

- Gasket of high temperature silicone
- Small footprint adjustable mounting bracket 135°
- Wiring Harness of 1 meter or 2 meter can be ordered for easy looping of Lights.
- Toughened extra clear safety glass 3.2mm incorporated

- Wire for mains supply cable 3c×1.5mm²
- IP-67 connector provided cable O.D. 6-10mm
- Reiz Electronic LED driver constant current integrated, THD<10% PF>0.95, LED CRI : 85
- Optional (RGB/W)

PATHWAY LUMINAIRES

A range of aesthetic and chic designs that go with a variety of landscapes. Diffused glow is used to accentuate and illuminate outdoor areas. Plus, there is an option of customising the luminaire using LED color and finish.

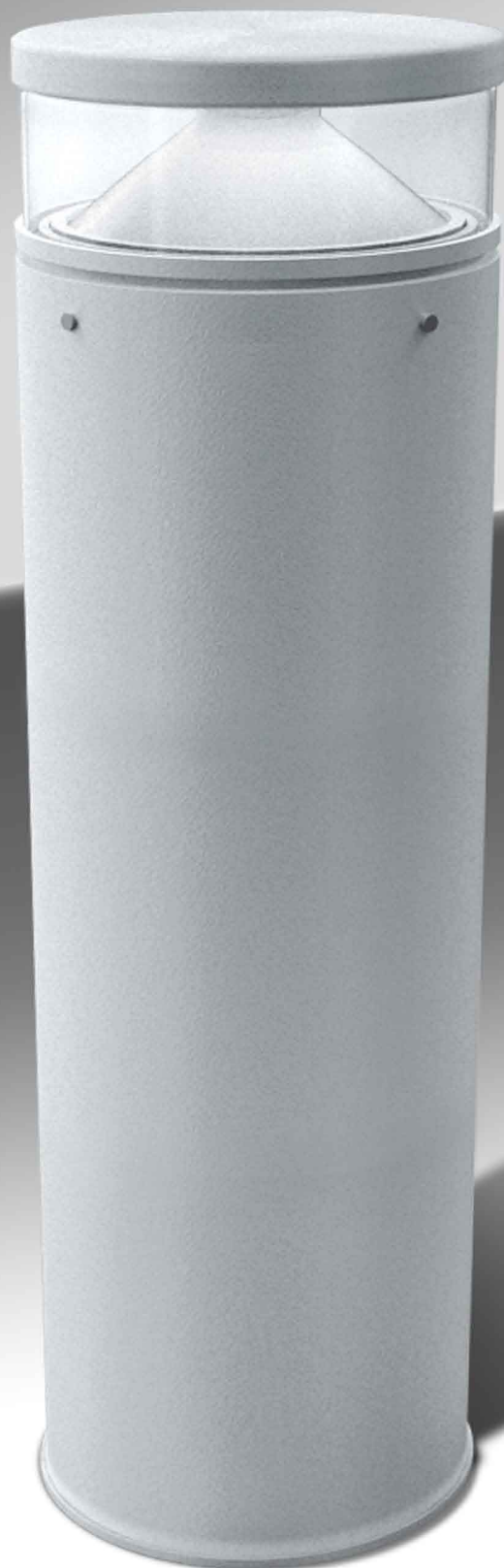

Bollard 360

Bollard Sleek

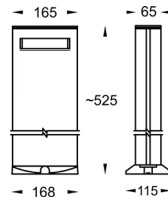

09713800204 001 500

9W 890lm 6000K

Optics :180°

Led Color		Finish	
C	6000K	W	White
N	4000K	B	Black
W	3000K	S	Silver

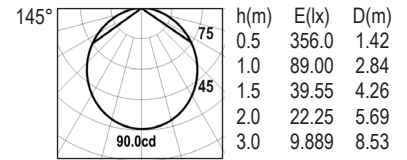

- Floor mounted bollard provides soft diffused light with one sided wash with light output 180 degree for use in pathways
- Construction in extruded aluminium, diecast aluminium and high transmittance PMMA diffuser

- Polyester powder coated with high U.V. & corrosion resistance
- Silicone gasket for moisture protection
- Extruded aluminium for better heatsink of LED
- Stainless steel 304 anchorage fasteners for concrete mounting

- All hardware is SS-304
- Mains supply cable upto 3c×1.5mm²
- IP-67 connector provided cable O.D. 6-10mm
- Reiz Electronic LED driver constant current integrated, THD<10% PF>0.95
- LED CRI : 85

Bollard Oval 180

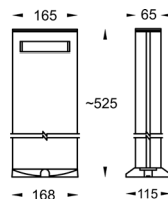

09713800204 001 500

9W 890lm 6000K

Optics :180°

Led Color		Finish	
C	6000K	W	White
N	4000K	B	Black
W	3000K	S	Silver

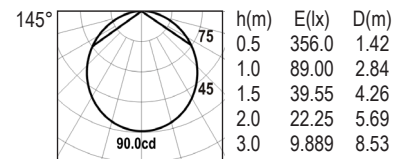

- Floor mounted bollard provides soft diffused light with one sided wash with light output 180 degree for use in pathways
- Construction in extruded aluminium, diecast aluminium and high transmittance PMMA diffuser

- Polyester powder coated with high U.V. & corrosion resistance
- Silicone gasket for moisture protection
- Extruded aluminium for better heatsink of LED
- Stainless steel 304 anchorage fasteners for concrete mounting

- All hardware is SS-304
- Mains supply cable upto 3c×1.5mm²
- IP-67 connector provided cable O.D. 6-10mm
- Reiz Electronic LED driver constant current integrated, THD<10% PF>0.95
- LED CRI : 85

Bollard 360

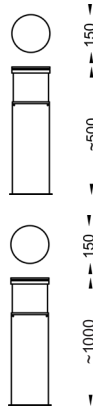

0970280R524 ■ 001 ■ 500
9W 790lm 6000K

Led Color	Finish
C 6000K	W White
N 4000K	B Black
W 3000K	S Silver

09702800115 ■ 001 ■ 500
16W 1422lm 6000K
Optics : 360°

Led Color	Finish
C 6000K	W White
N 4000K	B Black
W 3000K	S Silver

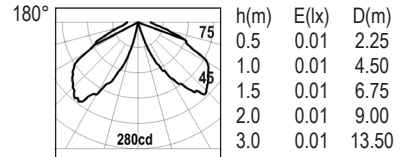

- The Bollard 360 gives extremely wide & even light pattern, allows the fixture to be placed near pathways & gardens
- Floor mounted bollard provides symmetrical lights around the bollard upto a diameter of approx 10m
- Construction in extruded aluminium, extra clear polycarbonate as diffuser

- Polyester powder coated with high U.V. & corrosion resistance
- Silicone gasket for moisture protection
- Extruded aluminium for better heatsink of LED
- Stainless steel 304 anchorage fasteners for concrete mounting

- All hardware is SS-304
- Mains supply cable upto 3c×1.5mm²
- IP-67 connector provided cable O.D. 6-10mm
- Reiz Electronic LED driver constant current integrated, THD<10% PF>0.95
- LED CRI : 85

Bollard Oval 360

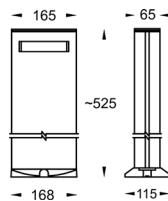

09702300208 ■ 001 ■ 500
9W 780lm 6000K
Optics : 360°

Led Color	Finish
C 6000K	W White
N 4000K	B Black
W 3000K	S Silver

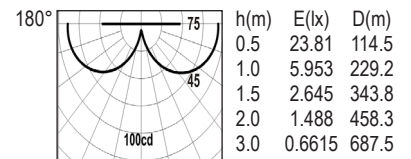

- Floor mounted bollard provides soft diffused light to foliage and pathway
- Construction in extruded aluminium, diecast aluminium and high transmittance PMMA diffuser

- Polyester powder coated with high U.V. & corrosion resistance
- Stainless steel 304 anchorage fasteners for concrete mounting
- Extruded aluminium for better heatsink of LED

- IP-67 connector provided cable O.D. 6-10mm
- Reiz Electronic LED driver constant current integrated, THD<10% PF>0.95
- LED CRI : 85

Mushroom

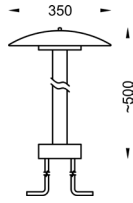

09717501501 001 500
 16W 1210lm 6000K
 Cut Off Angle : 45° Optics : 180°
Led Color **Finish**
 C 6000K W White
 N 4000K B Black
 W 3000K S Silver

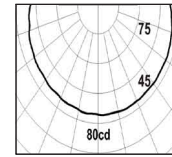

h(m)	E(lx)	D(m)
0.5	296.6	114.5
1.0	74.15	229.2
1.5	32.95	343.8
2.0	18.53	458.4
3.0	8.239	687.5



- The mushroom gives extremely wide & even light pattern, allows the fixture to be placed near pathways & gardens, to highlight foliage
- Construction in extruded aluminium
- Polyester powder coated with high U.V. & corrosion resistance

- Silicone gasket for moisture protection
- Toughened extra clear polycarbonate 3.2mm
- Extruded aluminium for better heatsink of LED
- Stainless steel 304 anchorage fasteners for concrete mounting
- All hardware is SS-304

- Mains supply cable upto 3c×1.5mm²
- IP-67 connector provided cable O.D. 6-10mm
- Reiz Electronic LED driver constant current integrated, THD<10% PF>0.95
- LED CRI : 85

Bollard Smile

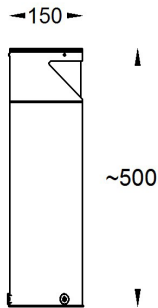

09714000209 001 500
 20W 1850lm 6000K
 Optics :180°
Led Color **Finish**
 C 6000K W White
 N 4000K B Black
 W 3000K S Silver

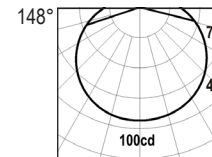

h(m)	E(lx)	D(m)
0.5	373.0	3.43
1.0	93.27	6.86
1.5	41.45	10.29
2.0	23.31	13.72
3.0	10.36	20.58



- Floor mounted bollard with one sided wash light output 180 degree for use in pathways or to highlight facades
- Construction in aluminium and high transmittance PMMA
- Polyester powder coated with high U.V. & corrosion resistance

- Silicone gasket for moisture protection
- Extruded aluminium for better heatsink of LED
- Stainless steel 304 anchorage fasteners for concrete mounting
- Reflector Al. 99.9% silver bright anodized
- All hardware is SS-304

- Wire for mains supply cable 3c×1.5mm²
- IP-67 connector provided cable O.D. 6-10mm
- Reiz Electronic LED driver constant current integrated, THD<10% PF>0.95
- LED CRI : 85

Bollard X

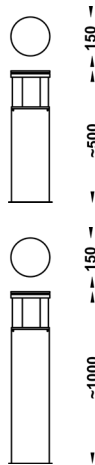

09714100209 451 500
 20W 1890lm 6000K 500mm
 Height : 500mm

Led Color	Finish
C 6000K	W White
N 4000K	B Black
W 3000K	S Silver



09814100208 451 500
 20W 1890lm 6000K 1000mm
 Height : 1000mm

Led Color	Finish
C 6000K	W White
N 4000K	B Black
W 3000K	S Silver



- The Bollard X gives two sided light 90 degree even light pattern, allows the fixture to be placed near pathways & gardens.
- Construction in aluminium & high transmittance PMMA.
- Stainless steel 304 anchorage fasteners for concrete mounting.

- Reflector Al. 99.9% silver bright anodized.
- Silicone gasket for moisture protection.
- All hardware is SS-304.
- Rubber H07RNF cable.
- Polyester powder coated with high U.V. & corrosion resistance.

- Wire for mains supply cable 3c×1.5mm²
- IP-67 connector provided cable O.D. 6-10mm
- Reiz Electronic LED driver constant current integrated, THD<10% PF>0.95.
- LED CRI : 85

Bollard L

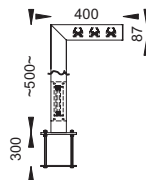

18002724W12 451 500
 24W 2080lm 6000K
 Length : 500mm

Led Color	Finish
C 6000K	W White
N 4000K	B Black
W 3000K	S Silver

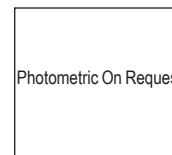

- Floor mounted bollard with one sided wash light output 180 degree for use in pathways or to highlight facades
- Construction in aluminium and high transmittance PMMA
- Polyester powder coated with high U.V. &

- corrosion resistance
- Silicone gasket for moisture protection
- Extruded aluminium for better heatsink of LED
- Stainless steel 304 anchorage fasteners for concrete mounting
- Reflector Al. 99.9% silver bright anodized

- All hardware is SS-304
- Wire for mains supply cable 3c×1.5mm²
- IP-67 connector provided cable O.D. 6-10mm
- Reiz Electronic LED driver constant current integrated, THD<10% PF>0.95
- LED CRI : 85



Select Mall - Saket Delhi

POLE TOP LUMINAIRES

Pole Top Luminaires can highlight wide swash area from height of 3 mtr OMO. They are manufactured using High Quality Polyster Carbonating for High Visibility.



Wayfarer

Wayfarer Ohm

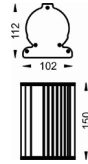

23100001000 ■ 001S600
 10W 1080lm 6000K
 Cut Off Angle : 15°
Led Color
 C 6000K
 N 4000K
 W 3000K

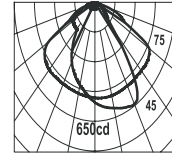

h(m)	E(lx)	D(m)
0.5	2088	1.25
1.0	521.9	2.51
1.5	231.9	3.76
2.0	130.4	5.01
3.0	57.99	7.53



23100001500 ■ 001S600
 15W 1640lm 6000K
 Cut Off Angle : 15°
Led Color
 C 6000K
 N 4000K
 W 3000K

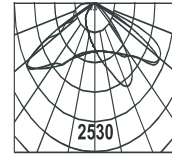

h(m)	E(lx)	D(m)
0.5	4129	0.95
1.0	1032	1.92
1.5	458.7	2.88
2.0	258	3.84
3.0	114.6	5.75



23100002500 ■ 001S600
 25W 2730lm 6000K
 Cut Off Angle : 10°
Led Color
 C 6000K
 N 4000K
 W 3000K



h(m)	E(lx)	D(m)
0.5	416.4	7.04
2.0	46.23	23.82
2.5	26.00	31.76
3.0	11.55	47.64



23100005000 ■ 001S600
 50W 5480lm 6000K
 Cut Off Angle : 10°
Led Color
 C 6000K
 N 4000K
 W 3000K



h(m)	E(lx)	D(m)
0.5	416.4	7.04
2.0	46.23	23.82
2.5	26.00	31.76
3.0	11.55	47.64



23100010000 ■ 001S600
 100W 10960lm 6000K
 Cut Off Angle : 10°
Led Color
 C 6000K
 N 4000K
 W 3000K



h(m)	E(lx)	D(m)
0.5	416.4	7.04
2.0	46.23	23.82
2.5	26.00	31.76
3.0	11.55	47.64



23100015000 ■ 001S600
 150W 16470lm 6000K
 Cut Off Angle : 10°
Led Color
 C 6000K
 N 4000K
 W 3000K



h(m)	E(lx)	D(m)
0.5	416.4	7.04
2.0	46.23	23.82
2.5	26.00	31.76
3.0	11.55	47.64



- Pole mounted LED street light with asymmetric light distribution with over 90% efficiency
- The main body in high conductive aluminium extension is designed for self cleaning ability
- Construction in extruded aluminium & Stainless steel
- Polyester powder coated with high U.V. & corrosion resistance

- Silicone gasket for moisture protection
- Toughened extra clear safe glass 4mm
- All hardware is SS-304
- Mounting system can handle Ø50 or Ø60mm pole
- Mains supply cable upto 3c×1.5mm²
- Input voltage regulation from 150VAC to 350VAC

- Easy replacement of LED driver via IP-67 connector for cable O.D. 6-12mm
- Reiz Electronic LED driver constant current integrated, THD<10% PF>0.95 IP67 Shurge protection upto 10kv
- H07 RNF rubber cable 3c×1.0mm sq.
- LED CRI : 70

Tower

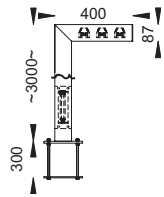

18002736W12 451S500

36W 3150lm 6000K
Length : 2600mm

Led Color	Finish
C 6000K	W White
N 4000K	B Black
W 3000K	S Silver

18002705000 251S500

50W 4375lm 6000K
Length : 2600mm

Led Color	Finish
C 6000K	W White
N 4000K	B Black
W 3000K	S Silver

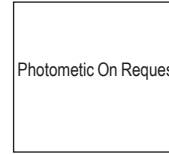

- Pole mounted LED street light with asymmetric light distribution with over 90% efficiency
- The main body are designed for self cleaning ability
- Construction in extruded aluminium & mild steel pole
- Polyester powder coated with high U.V. & corrosion resistance

- Silicone gasket for moisture protection
- Toughened extra clear safe glass 4mm
- All hardware is SS-304
- Mounting system can handle Ø75 or Ø100 pole
- Adjustable luminaire ±25°

- Mains supply cable upto 3c×1.5mm²
- IP-67 connector provided cable O.D. 6-10mm
- Reiz Electronic LED driver constant current integrated, THD<10% PF>0.95
- LED CRI : 85

Pole Top Lantern

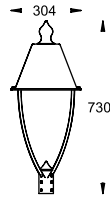

099126024093001Z500

20W 1856lm 6000K
Cut Off Angle : 10°

Led Color		Finish	
C	6000K	W	White
N	4000K	B	Black
W	3000K	S	Silver

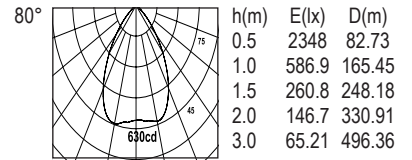

099126030093001Z500

30W 2734lm 6000K
Cut Off Angle : 10°

Led Color		Finish	
C	6000K	W	White
N	4000K	B	Black
W	3000K	S	Silver

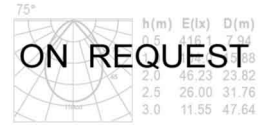

099126050093001Z500

40W 3645lm 6000K
Cut Off Angle : 10°

Led Color		Finish	
C	6000K	W	White
N	4000K	B	Black
W	3000K	S	Silver

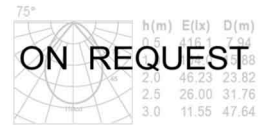

- Pole mounted LED street light with asymmetric light distribution with over 90% efficiency
- The main body are designed for self cleaning ability
- Construction in extruded aluminium & mild steel pole
- Polyester powder coated with high U.V. & corrosion resistance

- Silicone gasket for moisture protection
- Toughened extra clear safe glass 4mm
- Strain Relief cable clamp with terminal block
- Lamp Holder Carrier in extruded aluminium for better heatsink of LED
- Wire from Mains supply cable upto 3core X1.5mm² (8-10mm OD)

- Reiz Electronic LED driver constant current integrated, THD<10% PF>0.95
- LED consistent to 4 macadam ellipse.
- Pole can be ordered separately.
- LED CRI : 85

Pole Top Dome

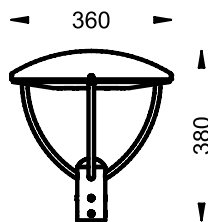

09702800115 001S500

20W 1856lm 6000K
Cut Off Angle : 30°

Led Color		Finish	
C	6000K	W	White
N	4000K	B	Black
W	3000K	S	Silver

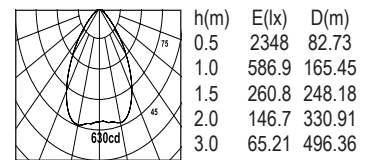

09702800030 001S500

30W 2694lm 6000K
Cut Off Angle : 10°

Led Color		Finish	
C	6000K	W	White
N	4000K	B	Black
W	3000K	S	Silver



- Pole mounted LED street light with asymmetric light distribution with over 90% efficiency
- The main body are designed for self cleaning ability
- Construction in extruded aluminium & mild steel pole
- Polyester powder coated with high U.V. & corrosion resistance

- Silicone gasket for moisture protection
- Toughened extra clear safe glass 4mm
- Strain Relief cable clamp with terminal block
- Lamp Holder Carrier in extruded aluminium for better heatsink of LED
- Wire from Mains supply cable upto 3core X1.5mm² (8-10mm OD)

- Reiz Electronic LED driver constant current integrated, THD<10% PF>0.95
- LED consistent to 4 macadam ellipse.
- LED CRI : 85

